

Proper Environment

- Protection class: IP67 (applies only when sensor cable is plugged in)
- Lenses are excluded from the protection class. Contamination of the lenses causes impairment or failure of the function.
- Temperature range
 - Operation: -10 ... +50 °C
 - Storage: -25 ... +70 °C
- Humidity: 5 ... 95 % RH (non-condensing)
- Ambient pressure: Atmospheric pressure

Unpacking/Included in Delivery

1 Sensor ILR3800 1 German laser information sign 1 Mounting set 1 Installation instructions

Sensor Fastening

The optoNCDT ILR3800 sensors are optical sensors that operate with millimeter accuracy.

- Ensure careful handling during installation and operation

➡ Only attach the sensor on a flat surface using the holes provided. Any type of clamping is not permitted.

➡ Mount the sensor on the sensor base plate using two M4 screws.

In addition, the sensor can be adjusted using 4 set screws.

Term Definitions, Analog Output Displacement

For ILR3800 sensors, the start of the measuring range is placed in front of the sensor. The point of reference is the front housing edge on the sensor housing.

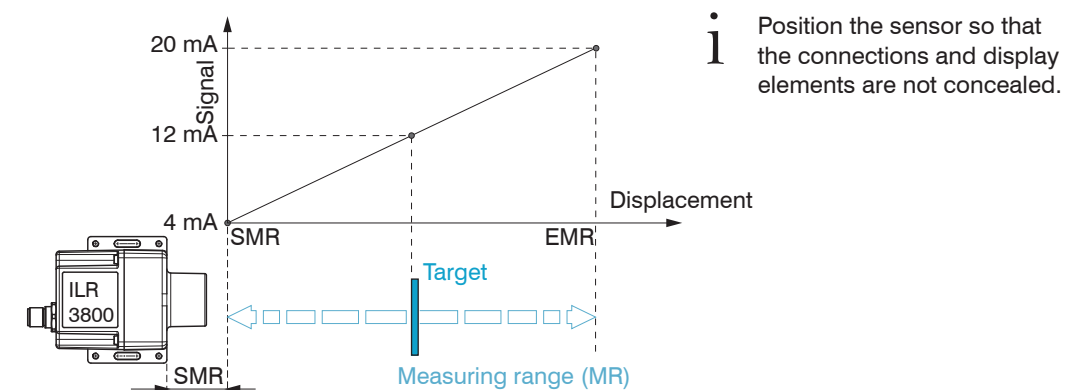

• Position the sensor so that the connections and display elements are not concealed.

- SMR Start of measuring range, minimum distance between sensor and target
- EMR End of measuring range (start of measuring range + measuring range), maximum distance between sensor and target
- MR Measuring range

Laser Spot Diameter, Min. Target Size

The laser spot diameter increases with increasing distance (displacement). Keep this in mind for the selection/size of the measuring object.

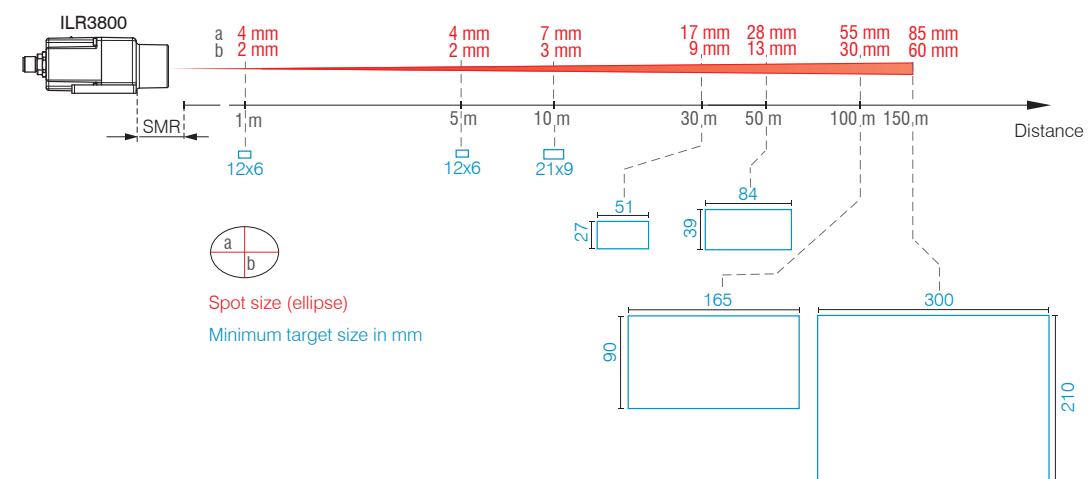

Fig. 2 Laser spot dimensions and size of measuring object depending on the distance

Fastening

Conditions for a bolt connection ¹

Bolt length	Screwing depth	Screw	Torque
6,5 mm	min 10 mm	M4 ISO 4762-A2, 4 pc.	1,7 Nm for strength class 70 2,3 Nm for strength class 80

1) Recommendation: Test under use conditions!

Sensor Installation, Dimensional Drawings

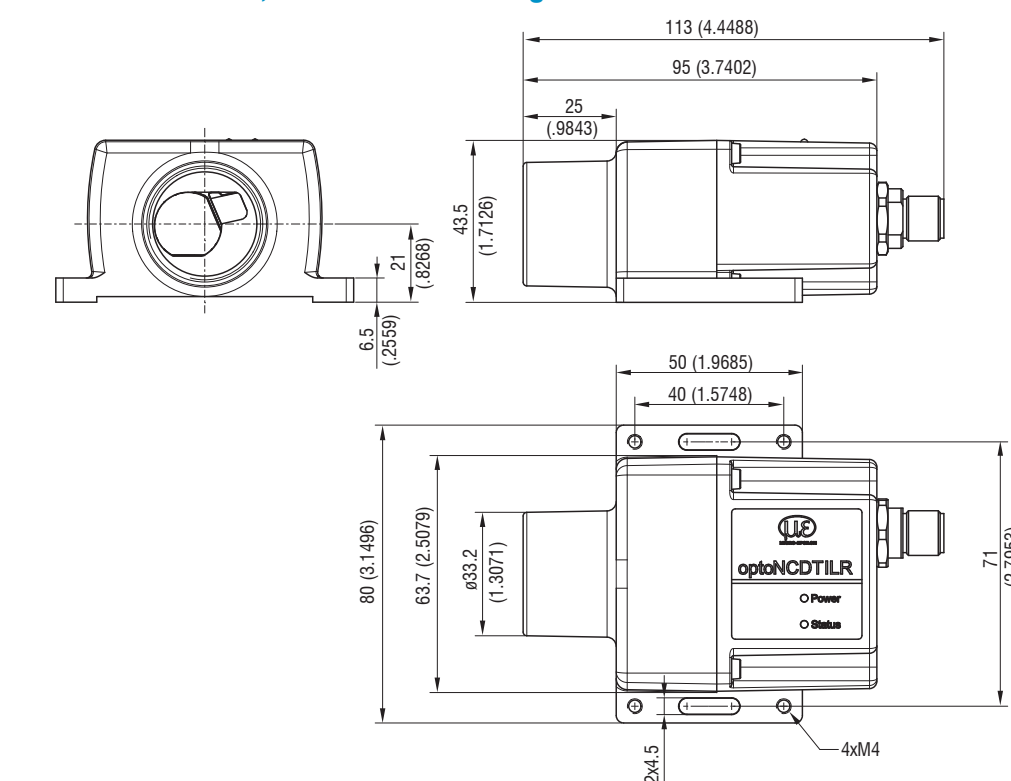

Fig. 3 Dimensional drawing optoNCDT ILR3800-100, dimensions in mm (inches, rounded off)

Reflector Installation

The sensor measures the distance to moving and stationary objects:

- In the range of 0.05 m ... 100 m for diffuse reflecting surfaces
- Between 35 and 150 m onto reflectors (e.g. ILR-RF210, Scotchlign by 3M etc.)

The measurement laser can be used for alignment. When aligning the sensor, proceed as follows:

- ➡ When measuring on reflectors or shiny surfaces, keep a distance of at least 35 m to avoid damage to sensor components caused by the reflected light. The visible point of light of the measurement laser should be in the center of the reflector.
- ➡ Position the sensor at least 35 m away from the reflector.
- ➡ Check that the measurement laser is pointing at the center of the reflector and adjust if necessary.

The center of the laser spot must be in the center of the reflector over the entire measuring range. Target (reflector) and sensor can only be tilted by at most 5° relative to one another.

Pin Assignment

Signal	Pin	PC3800-x cable color	Explanation	Comments, circuitry
RX+	1	White	RS422 input (symmetrical)	Internally terminated with 120 Ohm
RX-	2	Brown	RS422 input (symmetrical)	
TRIG	3	Green	MFI-Trigger	Multi-function input, t > 2 ms
I _{OUT}	4	Yellow	Analog output	4 ... 20 mA
TX-	5	Gray	RS422 output (symmetrical)	Receiver terminated with 120 Ohm
TX+	6	Pink	RS422 output (symmetrical)	
GND	7	Blue	Ground	Reference potential for power supply and analog output
+U _B	8	Red	Power supply 24 V	10 ... 30 VDC, typ. 24 VDC

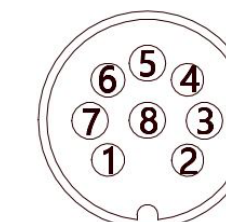

Pin side 8-pin housing connector

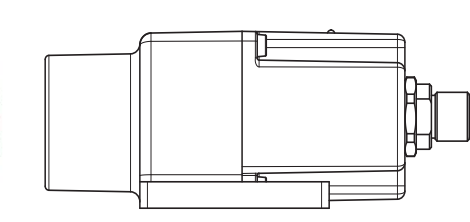

Power supply and signal socket M12x1; 8-pin.

The ground lines are connected internally and are the reference potential for all voltage values given below. All outputs are designed to be permanently resistant to short circuits.

The optionally available PC3800-x und PC3800/90-x supply/output cables can be used with drag chains and have the following bend radii: 47 mm (once) 116 mm (permanent)

NOTICE

Make sure that cable ends are not exposed. This could cause short circuits. Connecting input signals to outputs can damage the sensor!

Supply Voltage, Nominal value: 24 V DC (10 ... 30 V, P < 1.5 W)

Sensor Pin	PC3800-x cable color	Comments
7	Blue	Supply ground
8	Red	U _B

➡ Only turn on the power supply after wiring has been completed.

MICRO-EPSILON recommends using the optionally available PS2020 power supply.



Installation Instructions optoNCDT ILR3800

Intended Use

The optoNCDT ILR3800 is designed for use in industrial and laboratory applications. It is used for distance, displacement and position measurement. The system must only be operated within the limits specified in the technical data, see operating Instructions, Chap. 3.4.

The system must be used in such a way that no persons are endangered or machines and other material goods are damaged in the event of malfunction or total failure of the system. Take additional precautions for safety and damage prevention in case of safety-related applications.

Warnings

Connect the power supply according to the safety regulations for electrical equipment.
> Risk of injury, damage to or destruction of the sensor

The supply voltage must not exceed the specified limits. Install the sensor on a flat surface using the mountain holes/threaded holes provided, any type of clamping is permitted.

Avoid shocks and impacts to the sensor, protect the sensor cable against damage. Do not touch the lenses or protective windows. Remove any fingerprints immediately using pure alcohol and a clean cotton cloth without leaving any streaks. Do not operate the sensor if optical components are steamed up or dirty.
> Damage to or destruction of the sensor, failure of the measuring device

Laser Safety

The optoNCDT ILR3800 works with a semiconductor laser with a wavelength of 655 nm (visible/red). The sensors fall within laser class 2. The laser is operated on a pulsed mode, the maximum optical power is ≤ 1 mW. Operation of the laser is indicated visually by the Status LED on the sensor. The warning sign below, siehe Fig. 1, is attached to the sensor housing (front side):



Fig. 1 Laser warning sign and laser label, IEC

The German laser information sign is enclosed and must be attached before the sensor is used for the first time.



Laser radiation. Irritation or injury of the eyes possible. Close your eyes or immediately turn away if the laser beam hits the eye.

Analog Output

The sensor produces a current output of 4 ... 20 mA.

- The output may not be used continuously in short-circuit operation without a load resistor.
- Continuous short-circuit operation leads to thermal overloading and thus causes the output to switch off automatically.

The current impressed in the line is proportional to the measured distance.

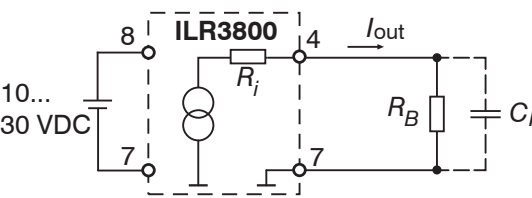

Sensor Pin	PC3800-x cable color	Comments
4	Yellow	Analog output
7	Blue	Ground

Analog output properties

- 4 ... 20 mA
 - Behavior when error reported: 3 mA
 - Resistant to short circuits
 - Distance range limits adjustable
 - Resolution: 16 bit DA converter
- Load
 $R_B < U_B - 1 V / 20 \text{ mA}$
 @10 V: $R_B < 450 \text{ Ohm}$
 @24 V: $R_B < 1150 \text{ Ohm}$
 @30 V: $R_B < 1450 \text{ Ohm}$
 $R_i 30 \text{ Ohm}$

RS422 Connection with USB Converter IF2001/USB

For the connection between sensor and PC, the lines must be crossed.

- Only disconnect or connect the sub-D connection between the RS422 and USB converter when no voltage is flowing.

Sensor		Terminal, PLC, IF2001/USB converter from MICRO-EPSILON	
Pin	Cable color (cable: PC3800-x)	Function	Function
1	White	Rx+	Tx+
2	Brown	Rx-	Tx-
5	Gray	Tx-	Rx-
6	Pink	Tx+	Rx+
7	Blue	GND	GND

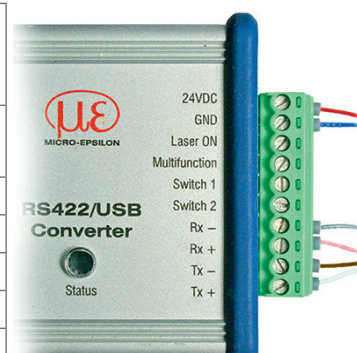

Symmetrical differential signals according to EIA-422, not electrically separated from the voltage supply. Use a shielded cable with twisted wires, e. g. PC3800-x. The RS422 interface can be used for configuration as well as for permanent data transmission, even over longer distances.

Multi-function input

The multi-function input enables the triggering, data acquisition/data output and zeroing/mastering. For further details please refer to the operating instructions of the sensor.

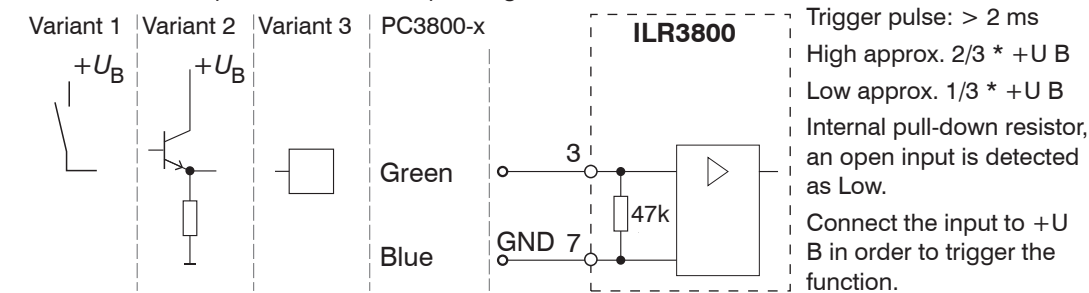

Fig. 4 Basic circuit for multi-function input

You can find more information about the sensor in the operating instructions. They are available online at: www.micro-epsilon.de/download/manuals/man--optoNCDT-ILR-38xx--en.pdf



Quick Guide

Structure of the Components

- Mount the sensor and connect the components.

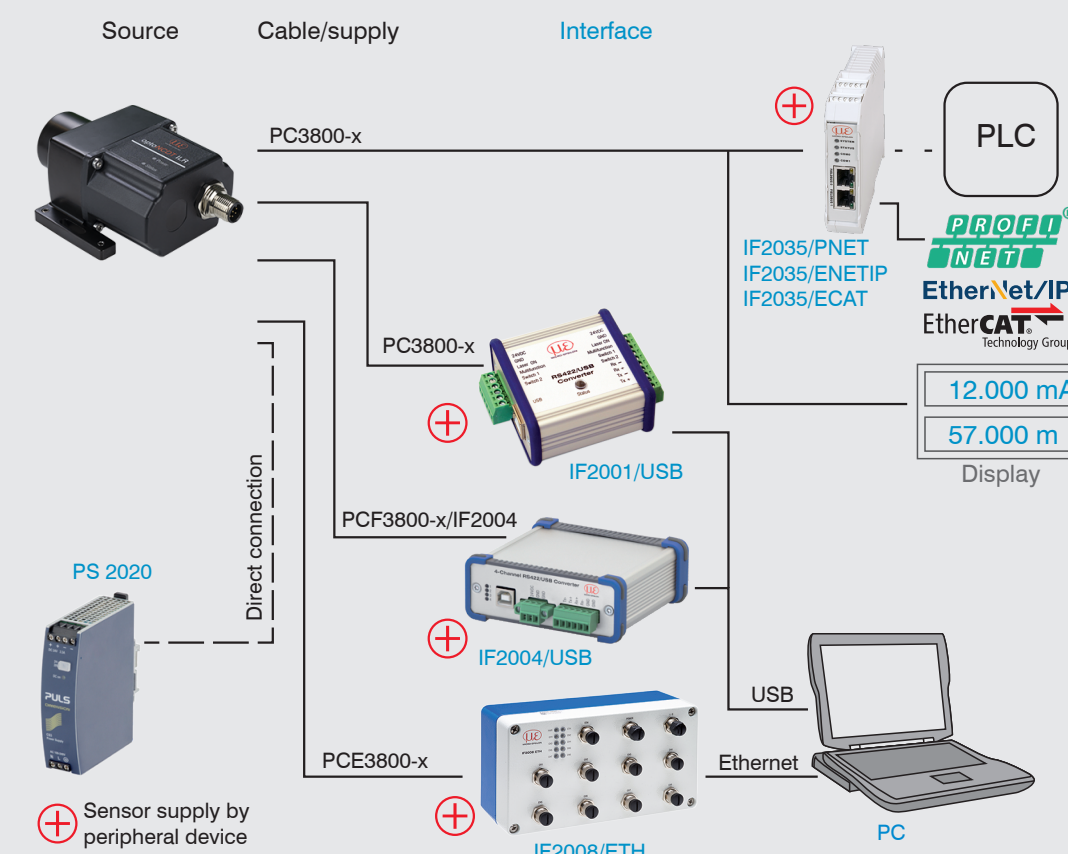

⊕ Sensor supply by peripheral device

MICRO-EPSILON Eltrotec GmbH
 Manfred-Wörner-Straße 101 • 73037 Göppingen / Germany
 Tel. +49 (0)7161 98872-300 • Fax+49 (0)7161 98872-303
 eltrotec@micro-epsilon.de • www.micro-epsilon.com

Your local contact: www.micro-epsilon.com/contact/worldwide/



Initial Operation

The measurement laser starts when the supply voltage is applied if an active measurement (see LASER MEASURE) has previously been saved in the sensor.

The sensor is ready to use after approx. 2 s, digital accuracy is immediate. The sensor typically requires a warm-up time of 5 min for reproducible measurements via the analog output.

- Connect the sensor to a PC/notebook via an RS422 converter and connect the power supply.
- Launch the sensorTOOL program.
- Click on the Sensor button.

The program will now search for connected ILR3800 sensors on the available interfaces.

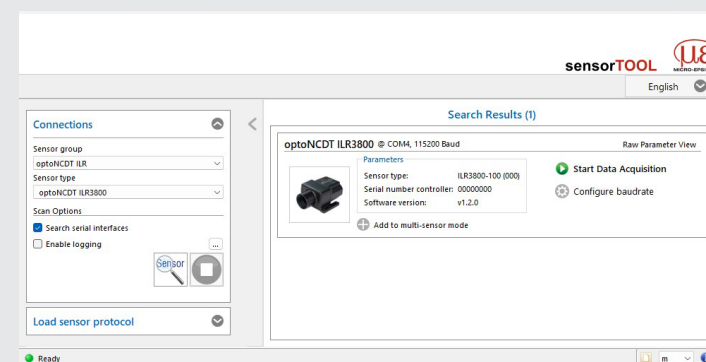

The Programm sensorTOOL program also finds connected sensors via a network. You can find this program online at <https://www.micro-epsilon.de/download/software/sensorTOOL.exe>.

- Select a desired sensor. Click the Start Data Acquisition button. The measurement chart offers diverse selection and filter options.

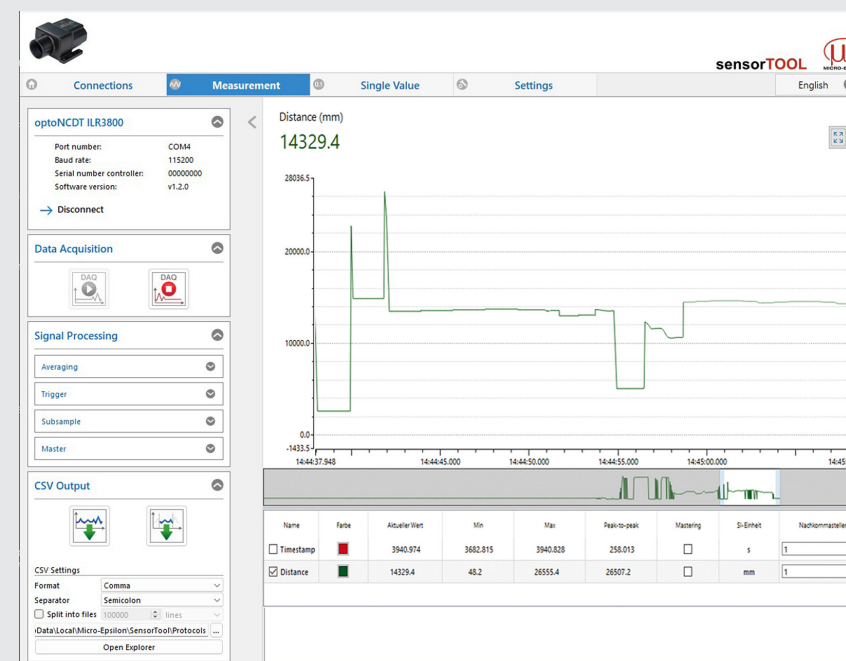

Presets, Analog Output, Switching Outputs

- Switch to the Settings menu.

By selecting a measurement mode in the Data Acquisition section, you can switch between the saved configurations (presets) for various target surfaces and target movement speeds. This will produce the best results for the material selected.

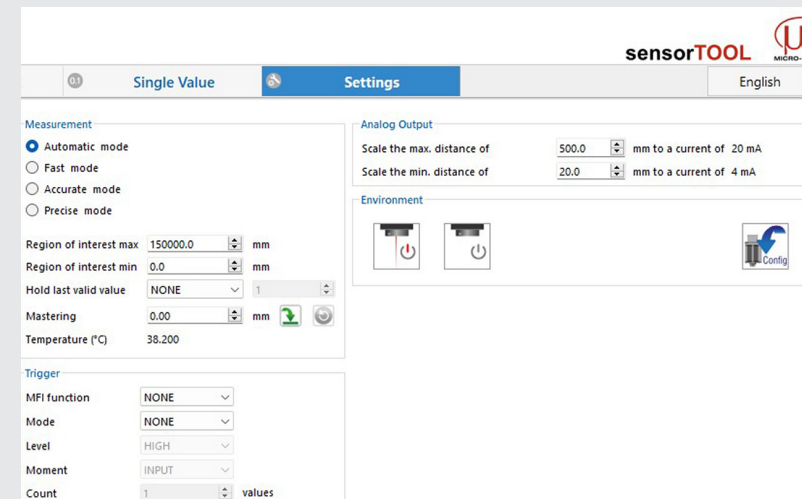

Display Elements, LED

LED	Function	Display	Status
Status	Reflection strength	Green	Signal very good
		Yellow	Signal satisfactory
		Red	Weak signal/error
Power	Operational readiness	Off	No supply voltage
		Green	Ready to use
		Yellow	Warm-up phase ¹



1) The ILD3800-100-H sensors with integral climate function only

Save the settings

After programming, save all settings permanently so that they will be available again the next time you switch on the sensor.

- Go to the Settings > Environment menu and click on the Config button.

