



Operating Instructions  
**thermoMETER CT**

CT-SF  
CTF  
CTH

CTM-1  
CTM-2  
CTM-3

CTP-3  
CTP-7

**Infrared sensor**

**MICRO-EPSILON  
MESSTECHNIK  
GmbH & Co. KG  
Koenigbacher Str. 15**

94496 Ortenburg / Germany

Tel. +49 (0) 8542 / 168-0  
Fax +49 (0) 8542 / 168-90  
info@micro-epsilon.com  
www.micro-epsilon.com

---

# Contents

<b>1.</b>	<b>Safety .....</b>	<b>7</b>
1.1	Symbols Used .....	7
1.2	Warnings .....	7
1.3	Notes on CE Marking .....	8
1.4	Intended Use .....	9
1.5	Proper Environment.....	9
<b>2.</b>	<b>Laser Safety.....</b>	<b>10</b>
<b>3.</b>	<b>Technical Data .....</b>	<b>11</b>
3.1	Functional Principle .....	11
3.2	Sensor Models.....	12
3.3	General Specifications.....	13
3.4	Electrical Specifications.....	14
3.5	Measurement Specifications .....	15
3.5.1	CT Model .....	15
3.5.2	CTF / CTH Models.....	16
3.5.3	CTM Models .....	17
3.5.4	CTP Models .....	20
<b>4.</b>	<b>Delivery .....</b>	<b>21</b>
4.1	Unpacking.....	21
4.2	Storage .....	21
<b>5.</b>	<b>Optical Charts.....</b>	<b>22</b>
<b>6.</b>	<b>Mechanical Installation .....</b>	<b>30</b>
<b>7.</b>	<b>Electrical Installation.....</b>	<b>33</b>
7.1	Cable Connections .....	33
7.1.1	Pin Assignment.....	33
7.1.1.1	CT-SF02, CT-SF15, CT-SF22, CTF-SF15, CTF-SF25, CTH-SF02, CTH-SF10, CTP-7 and CTP-3 Models .....	33
7.1.1.2	CTM-1, CTM-2, CTM-3 Models .....	34
7.2	Power Supply.....	34
7.3	Cable Assembling.....	35

7.4	Ground Connection .....	36
7.4.1	CTM Models .....	36
7.4.2	CT-SF, CT-CF, CTF, CTH, CTP Models.....	37
7.5	Exchange of the Sensor .....	38
7.5.1	Entering of the Calibration Code.....	38
7.5.2	Sensor Cable.....	39
<b>8.</b>	<b>Outputs and Inputs.....</b>	<b>40</b>
8.1	Analog Outputs.....	40
8.1.1	Output Channel 1 .....	40
8.1.2	Output Channel 2 (only CT-SF02, CT-SF15, CT-SF22, CTH, CTP-7 and CTP-3) .....	40
8.2	Digital Interfaces .....	41
8.2.1	USB Interface .....	42
8.2.1.1	Installation .....	42
8.2.1.2	Driver Installation of Interface.....	42
8.2.2	RS232 Interface .....	43
8.2.2.1	Installation .....	43
8.2.2.2	Software Installation .....	43
8.2.3	RS485 Interface .....	44
8.2.3.1	Installation .....	44
8.2.3.2	Sensor Installation.....	45
8.2.4	Profibus Interface .....	46
8.2.4.1	Installation .....	46
8.2.4.2	Commissioning Profibus.....	47
8.2.5	CAN BUS Interface .....	48
8.2.6	Modbus RTU.....	50
8.2.6.1	Serial Interface Parameters.....	50
8.2.6.2	Protocol .....	50
8.2.6.3	Installation Overview .....	50
8.2.6.4	Connection of More than one Device (Synchronisation) .....	53
8.2.6.5	Overview of Digital Commands for Modbus RTU Digital Interfaces for CT and CTLaser Sensors.....	53
8.2.7	Ethernet Interface .....	54
8.2.7.1	Installation .....	54
8.2.7.2	Installation of the Ethernet Adapter in a Network .....	54
8.2.7.3	Uninstalling the Ethernet Adapter in a Network.....	58
8.2.7.4	Direct Connection to a PC .....	59
8.2.7.5	Settings inside the CompactConnect Software.....	64
8.2.7.7	Resetting the Ethernet Adapter.....	65

8.3	Relays Outputs .....	66
8.4	Functional Inputs .....	67
8.5	Alarms .....	68
8.5.1	Output Channel 1 and 2 (Channel 2 on CT-SF / CTP-7 and CTP-3) .....	68
8.5.2	Visual Alarms .....	68
8.5.3	Open Collector Output / AL2 .....	69
<b>9.</b>	<b>Operating .....</b>	<b>70</b>
9.1	Restoring Factory Setting .....	70
9.2	Sensor Setup .....	72
9.3	Explanation to the Menu Items .....	73
9.4	Error Messages .....	76
9.4.1	CT-SF02, CT-SF15, CT-SF22, CTH and CTP Models .....	76
9.4.2	CTM-1, CTM-2, CTM-3 Models .....	76
<b>10.</b>	<b>Instructions for Operation .....</b>	<b>77</b>
10.1	Cleaning .....	77
<b>11.</b>	<b>CompactConnect Software .....</b>	<b>78</b>
11.1	System Requirements .....	78
11.2	Main Features .....	78
<b>12.</b>	<b>Communication Settings .....</b>	<b>79</b>
12.1	Serial Interface .....	79
12.2	Protocol .....	79
12.3	ASCII Protocol .....	80
12.4	Saving of Parameter Settings .....	81
<b>13.</b>	<b>Basics of Infrared Thermometry .....</b>	<b>82</b>
<b>14.</b>	<b>Emissivity .....</b>	<b>83</b>
14.1	Definition .....	83
14.2	Determination of Unknown Emissivity .....	83
14.3	Characteristic Emissivity .....	84
<b>15.</b>	<b>Liability for Material Defects .....</b>	<b>85</b>

---

<b>16.</b>	<b>Service, Repair .....</b>	<b>86</b>
------------	------------------------------	-----------

<b>17.</b>	<b>Decommissioning, Disposal .....</b>	<b>86</b>
------------	----------------------------------------	-----------

## **Appendix**

<b>A 1</b>	<b>Accessories .....</b>	<b>87</b>
------------	--------------------------	-----------

A 1.1	Mounting Accessories .....	87
-------	----------------------------	----

A 1.2	Air Purge Collars .....	89
-------	-------------------------	----

A 1.2.1	Standard Air Purge Collar .....	89
---------	---------------------------------	----

A 1.2.2	Laminar Air Purge Collar .....	90
---------	--------------------------------	----

A 1.3	CF Lens and Protective Window .....	91
-------	-------------------------------------	----

A 1.4	Further Accessories .....	95
-------	---------------------------	----

A 1.4.1	Right Angle Mirror .....	95
---------	--------------------------	----

A 1.4.2	Rail Mount Adapter for Controller .....	96
---------	-----------------------------------------	----

A 1.4.3	Tilt Assembly for CT Sensors .....	96
---------	------------------------------------	----

A 1.4.4	Laser Sighting Tool .....	97
---------	---------------------------	----

A 1.4.5	OEM Laser Sighting Tool .....	98
---------	-------------------------------	----

A 1.4.6	Massive Housing .....	99
---------	-----------------------	----

A 1.4.7	Accessories for Massive Housing .....	100
---------	---------------------------------------	-----

A 1.4.9	Pipe Adapter and Sighting Tubes .....	101
---------	---------------------------------------	-----

<b>A 2</b>	<b>Factory Settings .....</b>	<b>102</b>
------------	-------------------------------	------------

<b>A 3</b>	<b>Emissivity Table Metals .....</b>	<b>104</b>
------------	--------------------------------------	------------

<b>A 4</b>	<b>Emissivity Table Non Metals .....</b>	<b>107</b>
------------	------------------------------------------	------------

<b>A 5</b>	<b>Smart Averaging .....</b>	<b>109</b>
------------	------------------------------	------------

## 1. Safety

System operation assumes knowledge of the operating instructions.

### 1.1 Symbols Used

The following symbols are used in these operating instructions.



Indicates a hazardous situation which, if not avoided, may result in minor or moderate injury.



Indicates a situation that may result in property damage if not avoided.



Indicates a user action.



Indicates a tip for users.

Measure

Indicates hardware or a software button/menu.

### 1.2 Warnings



Connect the power supply and the display/output device in accordance with the safety regulations for electrical equipment.

> Risk of injury

> Damage to or destruction of the sensor and/or controller



Avoid shock and vibration to the sensor and the controller.

> Damage to or destruction of the sensor and/or controller

Avoid mechanical violence on the sensor.

> Damage to or destruction of the sensor

The supply voltage must not exceed the specified limits.

> Damage to or destruction of the sensor and/or controller

Protect the sensor cable against damage.

> Destruction of the sensor, failure of the measuring device

Do not kink the sensor cable and bend the sensor cable in tight radius. The minimum bending radius is 14 mm (static). A dynamic movement is not allowed.

> Damage to the sensor cable, failure of the measuring device

No solvent-based cleaning agents may have an effect on the sensor (neither for the optics nor the housing)

> Damage to or destruction of the sensor

Avoid abrupt changes of the ambient temperature.

> Inaccurate or incorrect measurements

### **1.3 Notes on CE Marking**

The following apply to the thermoMETER CT:

- EU Directive 2014/30/EU
- EU Directive 2011/65/EU, "RoHS" category 9

Products which carry the CE mark satisfy the requirements of the EU directives cited and the European harmonized standards (EN) listed therein. The measuring system is designed for use in industrial environments and meets the requirements.

The EU Declaration of Conformity is available to the responsible authorities according to EU Directive, article 10.



## 1.4 Intended Use

- The thermoMETER CT is designed for use in industrial and laboratory areas. It is used for non-contact temperature measurement.
- The system must only be operated within the limits specified in the technical data, [see 3](#).
- The sensor must be used in such a way that no persons are endangered or machines and other material goods are damaged in the event of malfunction or total failure of the controller.
- Take additional precautions for safety and damage prevention in case of safety-related applications.

## 1.5 Proper Environment

- Protection class:
  - Sensor: IP 65 (NEMA 4)
  - Controller: IP 65 (NEMA 4)
- Ambient temperature:
  - Sensor: See also Chapter Measurement Specification, [see 3.5](#)
  - Controller: 0 ... +85 °C (+32 ... +185 °F)

**NOTICE**

Avoid abrupt changes of the ambient temperature of both the sensor and the controller.  
> Inaccurate measuring values

- Storage temperature:
  - Sensor: See also Chapter Measurement Specification, [see 3.5](#)
  - Controller: -40 ... +85 °C (-40 ... +185 °F)
- Humidity: 10 ... 95 %, non-condensing

## 2. Laser Safety

The optional available laser-sighting tools (TM-LST-CT and TM-LSTOEM-CT) for thermoMETER CT, see A 1.4.4, operate with a semiconductor laser with a wavelength of 500 ... 650 nm (visible/red).

The laser falls within laser class 2 (II). The maximum optical power is  $\leq 1$  mW.

**i** Observe the laser protection regulations.

### **CAUTION**

Laser radiation.  
Irritation or injury of the eyes possible. Close your eyes or immediately turn away if the laser beam hits the eye.

Although the laser output is low, directly looking into the laser beam must be avoided. Close your eyes or immediately turn away if the laser beam hits the eye. For repair and service purposes, the sensor must always be sent to the manufacturer.

Lasers of class 2 (II) are not subject to notification and a laser protection officer is not required.

The following warning label must be attached to the cover (front side) of the laser-sighting tool housing:



*Fig. 1 Laser warning sign and laser label*

During operation of the sensor, the pertinent regulations according to IEC 60825-1 on “Safety of laser products” must be fully observed at all times. The sensor complies with all applicable laws for the manufacturer of laser devices.

### 3. Technical Data

#### 3.1 Functional Principle

The sensors of the thermoMETER CT series are non-contact measuring infrared temperature sensors. They calculate the surface temperature based on the emitted infrared energy of objects, [see 13](#)

The sensor housing of the thermoMETER CT is made from stainless steel (protection class. IP 65/ NEMA 4), the controller is placed in a separate box made of die casting zinc.

**i** The thermoMETER CT sensor is a sensitive optical system. Please only use the thread for mechanical installation.

<b>NOTICE</b>
---------------

Avoid mechanical violence on the sensor.

> Destruction of the system

### 3.2 Sensor Models

Model	Model codes	Measuring range	Spectral response	Typical applications
CT	CT-SF02 / CT-SF15	-50 to 600 °C	8 - 14 $\mu\text{m}$	Non-metallic surfaces
	CT-SF22	-50 to 975 °C		
CTF	CTF-SF15 / CTF-SF25	-50 to 975 °C	8 - 14 $\mu\text{m}$	Fast processes
CTH	CTH-SF02 / CTH-SF10	-40 to 975 °C	8 - 14 $\mu\text{m}$	High ambient temperatures (to 250 °C)
CTM-1SF	CTM-1SF40 / CTM-1SF75 / CTM-1SF75H1	485 to 2200 °C	1 $\mu\text{m}$	Metals and ceramic sur- faces
CTM-2SF	CTM-2SF40 / CTM-2SF75 CTM-2SF75H1	250 to 2000 °C	1.6 $\mu\text{m}$	Metals and ceramic sur- faces
CTM-3SF	CTM-3SF22 / CTM-3SF33 / CTM-3SF75H1 / CTM-3SF75H2 / CTM-3SF75H3	50 to 1800 °C	2.3 $\mu\text{m}$	Metals at low object tem- peratures (from 50 °C)
CTP-7	CTP-7SF10	0 to 710 °C	7.9 $\mu\text{m}$	Temperature of thin film plastics
CTP-3	CTP-3SF15	50 to 400 °C	3.43 $\mu\text{m}$	

In the following chapters of this manual you will find only the short model codes. On the CTM-1, CTM-2 and CTM-3 models the whole measuring range is split into several sub ranges.

### 3.3 General Specifications

	Sensor	Controller
Protection class	IP 65	
Ambient temperature	See also Chapter Measurement Specification, <a href="#">see 3.5</a>	0 ... 85 °C (+32 ... +185 °F) Only CTP-3: 0 ... 75 °C (+32 ... +167 °F)
Storage temperature	See also Chapter Measurement Specification, <a href="#">see 3.5</a>	-40 ... 85 °C (-40 ... +185 °F)
Relative humidity	10 ... 95 %, non-condensing	
Material	Stainless steel	Die casting zinc
Dimensions	28 mm x 14 mm, M12x1	89 mm x 70 mm x 30 mm
Dimensions CTH, CTP-7, CTP-3	55 mm x 29.5 mm, M18x1 (with massive housing)	89 mm x 70 mm x 30 mm
Weight	40 g (CTP-7 and CTP-3: 200 g)	420 g
Cable length	1 m (only CT-SF02, CT-SF15, CT-SF22, CTF-SF15, CTF-SF22), 3 m (standard at CTH, CTM <sup>1</sup> , CTP-7 and CTP-3), 8 m, 15 m	
Cable diameter	2.8 mm	
Ambient temperature cable	Max. 180 °C [High temperature cable for CtH: 250 °C]	
Vibration	IEC 68-2-6: 3 g 11 - 200 Hz, any axis	
Shock	IEC 68-2-27: 50 g, 11 ms, any axis	
Pressure resistance	8 bar	-
CompactConnect Software	optional	

1) The CTM-3 models are only available with 3 m cable.

### 3.4 Electrical Specifications

Power supply	8 - 36 VDC
Current draw	max. 100 mA
Outputs/ analog Channel 1	selectable: 0/4 - 20 mA, 0 - 5/10 V, thermocouple (J or K) or alarm output (Signal source: object temperature)
Channel 2 (only CT-SF02, CT-SF15, CT-SF22, CTP-7, CTP-3)	Sensor temperature [-20 ... 180 °C], [-20 ... 250 °C at CTH-SF02 or CTH-SF10], [0 ... 75 °C at CTP-3] as 0 – 5 V or 0 – 10 output or alarm output (Signal source switchable to object temperature or controller temperature if used as alarm output)
Alarm output	Open collector Output on Pin AL2 [24 V/50 mA]
Output impedances	max. loop resistance 500 Ω (at 8 - 36 VDC)
	min. 100 kΩ load impedance
	20 Ω
Digital interfaces	USB, RS232, RS485, CAN, Profibus DP, Ethernet, Modbus RTU (optional plug-in modules)
Relay outputs	2 x 60 VDC/42 VAC <sub>RMS</sub> , 0.4 A; potential free (optional plug-in modules)
Functional inputs	F1 up to F3; software programmable for the following functions: <ul style="list-style-type: none"> <li>- external emissivity adjustment</li> <li>- ambient temperature compensation,</li> <li>- trigger (reset of hold functions)</li> </ul> Input impedance F2 and F3: 43 kΩ

### 3.5 Measurement Specifications

#### 3.5.1 CT Model

Model	CT-SF02	CT-SF15	CT-SF22
Temperature range (scalable)	-50 ... 600 °C	-50 ... 600 °C	-50 ... 975 °C
Ambient temperature (sensor)	-20 ... 130 °C	-20 ... 180 °C	-20 ... 180 °C
Storage temperature (sensor)	-40 ... 130 °C	-20 ... 180 °C	-20 ... 180 °C
Spectral range	8 ... 14 μm		
Optical resolution	2:1	15:1	22:1
System accuracy <sup>1 2</sup>	±1 °C or ±1 % <sup>3</sup>		
Repeatability <sup>1</sup>	±0.5 °C or ±0.5 % <sup>3</sup>		
Temperature coefficient <sup>5</sup>	±0.05 K/ K or ±0.05 %/ K (whichever is greater)		
Temperature resolution (NETD) <sup>3 4</sup>	0.1 K	0.05 K	
Response time (95 % signal)	150 ms		
Warm-up time	10 min		
Emissivity/ gain	0.100 ... 1.100 (adjustable via programming keys or software)		
Transmissivity	0.100 ... 1.100 (adjustable via programming keys or software)		
Interface (optional)	USB, RS232, RS485, CAN, Profibus DP, Ethernet, Modbus RTU, (optional plug-in modules)		
Signal processing	Average, peak hold, valley hold (adjustable via programming keys or software)		
Software (optional)	CompactConnect		

1) At ambient temperature 23 ±5 °C; whichever is greater.

2) Accuracy for thermocouple output: ±2.5 °C or ±1 %

3) At object temperatures > 0 °C; ε = 1

4) At time constant 200 ms and an object temperature of 25 °C

5) For ambient temperatures (sensor): 18 °C ≤ sensor ≤ 28 °C



On the CT models CT-SF02 the sensor cable must not be moved during the measurement.

### 3.5.2 CTF / CTH Models

Model	CTF-SF15	CTF-SF25	CTH-SF02	CTH-SF10
Temperature range (scalable)	-50 ... 975 °C	-50 ... 975 °C	-40 ... 975 °C	-40 ... 975 °C
Ambient temperature (sensor)	-20 ... 120 °C	-20 ... 120 °C	-20 ... 250 °C	-20 ... 250 °C
Storage temperature (sensor)	-40 ... 120 °C	-40 ... 120 °C	-40 ... 250 °C	-40 ... 250 °C
Spectral range	8 ... 14 $\mu\text{m}$			
Optical resolution	15:1	25:1	2:1	10:1
System accuracy <sup>1 2</sup>	$\pm 2$ °C or $\pm 1$ % <sup>3</sup>		$\pm 1,5$ °C or $\pm 1$ % <sup>3</sup>	
Repeatability <sup>1</sup>	$\pm 0,75$ °C or $\pm 0,75$ % <sup>3</sup>		$\pm 0,5$ °C or $\pm 0,5$ % <sup>3</sup>	
Temperature coefficient <sup>5</sup>	$\pm 0.05$ K/ K or $\pm 0.05$ %/ K (whichever is greater)			
Temperature resolution (NETD) <sup>3 4</sup>	0.2 K	0.4 K	0.25 K	0.25 K
Response time (95 % signal)	9 ms	6 ms	100 ms	100 ms
Acquisition time (50 % signal)	4 ms	3 ms	-	-
Warm-up time	10 min			
Emissivity / gain	0.100 ... 1.100 (adjustable via programming keys or software)			
Transmissivity	0.100 ... 1.100 (adjustable via programming keys or software)			
Signal processing	Average, peak hold, valley hold (adjustable via programming keys or software)			
Software (optional)	CompactConnect			

1) At ambient temperature  $23 \pm 5$  °C; whichever is greater.

2) Accuracy for thermocouple output:  $\pm 2.5$  °C or  $\pm 1$  %

3) At object temperatures  $\geq 20$  °C;  $\varepsilon = 1$

4) At time constant 100 ms with smart averaging and an object temperature of 25 °C

5) For ambient temperatures (sensor):  $18$  °C  $\leq$  sensor  $\leq$   $28$  °C

**i** On the CT models CTH-SF02 and CTH-SF10 the sensor cable must not be moved during the measurement.



### 3.5.3 CTM Models

Model	CTM-1SF40	CTM-1SF75	CTM-1SF75H1	CTM-2SF40
Temperature range (scalable)	485 ... 1050 °C	650 ... 1800 °C	800 ... 2200 °C	250 ... 800 °C
Ambient temperature (sensor)	-20 ... 100 °C	-20 ... 100 °C	-20 ... 100 °C	-20 ... 125 °C
Storage temperature (sensor)	-40 ... 100 °C	-40 ... 100 °C	-40 ... 100 °C	-40 ... 125 °C
Spectral range	1 μm			1,6 μm
Optical resolution	40:1	75:1	75:1	40:1
System accuracy <sup>1 2</sup>	± (0.3 % of reading + 2 °C) <sup>3</sup>			
Repeatability <sup>1</sup>	± (0.1 % of reading + 1 °C) <sup>3</sup>			
Temperature coefficient <sup>5</sup>	±0.05 K/K or ±0.05 %/K (whichever is greater)			
Temperature resolution	0.1 K <sup>3</sup>			
Exposure time (90 % signal)	1 ms <sup>4</sup>			
Emissivity / gain	0.100 ... 1.100 (adjustable via programming keys or software)			
Transmissivity	0.100 ... 1.100 (adjustable via programming keys or software)			
Signal processing	Average, peak hold, valley hold (adjustable via programming keys or software)			
Software (optional)	CompactConnect			

1) At ambient temperature 23 ±5 °C.

2) Accuracy for thermocouple output: ±2,5 °C or ±1 %

3)  $\epsilon = 1$  / Response time 1 s

4) With dynamic adaptation at low signal levels

5) For ambient temperatures (sensor): 18 °C ≤ sensor ≤ 28 °C

Model		CTM-2SF75	CTM-2SF75H1	CTM-3SF22	CTM-3SF33
Temperature range (scalable) <sup>1</sup>		385 ... 1600 °C	490 ... 2000 °C	50 ... 400 °C <sup>1</sup>	100 ... 600 °C <sup>1</sup>
Ambient temperature	Sensor	-20 ... 125 °C		-20 ... 85 °C	
	Controller	0 ... 85 °C			
Storage temperature	Sensor	-40 ... 125 °C		-40 ... 85 °C	
	Controller	-40 ... 85 °C			
Spectral range		1.6 μm		2.3 μm	
Optical resolution		75:1	75:1	22:1	33:1
System accuracy <sup>2,3</sup>		± (0.3 % T <sub>MESS</sub> + 2 °C) <sup>4</sup>			
Repeatability <sup>2</sup>		± (0.1 % T <sub>MESS</sub> + 2 °C) <sup>4</sup>			
Temperature coefficient <sup>6</sup>		±0.05 K/K or ±0.05 %/K (whichever is greater)			
Temperature resolution		0.1 K <sup>4</sup>			
Exposure time (90 % signal)		1 ms <sup>5</sup>			
Emissivity / gain		0.100 ... 1.100 (adjustable via programming keys or software)			
Transmissivity		0.100 ... 1.100 (adjustable via programming keys or software)			
Signal processing		Average, peak hold, valley hold (adjustable via programming keys or software)			
Software (optional)		CompactConnect			

1) T<sub>Object</sub> > T<sub>Sensor</sub>+25 °C

2) At ambient temperature 23 ±5 °C

3) Accuracy for thermocouple output: ±2.5°C or ±1 %

4) ε = 1/ Response time 1 s

5) With dynamic adaptation at low signal levels

5) For ambient temperatures (sensor): 18 °C ≤ sensor ≤ 28 °C

Model	CTM-3SF75H1	CTM-3SF75H2	CTM-3SF75H3
Temperature range (scalable)	150 ... 1000 °C	200 ... 1500 °C	250 ... 1800 °C
Ambient temperature	Sensor	-20 ... 85 °C	
	Controller	0 ... 85 °C	
Storage temperature	Sensor	-40 ... 85 °C	
	Controller	-40 ... 85 °C	
Spectral range	2.3 μm		
Optical resolution	75:1		
System accuracy <sup>1 2</sup>	$\pm (0.3 \% T_{\text{of reading}} + 2 \text{ °C})$		
Response time <sup>1</sup>	$\pm (0.1 \% T_{\text{of reading}} + 1 \text{ °C})$ <sup>3</sup>		
Temperature coefficient <sup>5</sup>	$\pm 0.05 \text{ K/K}$ or $\pm 0.05 \%/\text{K}$ (whichever is greater)		
Temperature resolution	0.1 K <sup>3</sup>		
Response time (90 % signal)	1 ms <sup>4</sup>		
Emissivity / gain	0.100...1.100 (adjustable via programming keys or software)		
Transmissivity	0.100...1.100 (adjustable via programming keys or software)		
Signal processing	Average, peak hold, valley hold (adjustable via programming keys or software)		
Software (optional)	CompactConnect		

1) At ambient temperature  $23 \pm 5 \text{ °C}$ ; whichever is greater (CTP-7)

2) Accuracy for thermocouple output:  $\pm 2.5 \text{ °C}$  or  $\pm 1 \%$

3)  $\varepsilon = 1$  / Response time 1 s

4) With dynamic adaptation at low signal levels

5) For ambient temperatures (sensor):  $18 \text{ °C} \leq \text{sensor} \leq 28 \text{ °C}$

### 3.5.4 CTP Models

Model		CTP-7	CTP-3
Temperature range (scalable) <sup>6</sup>		0 ... 710 °C	50 ... 400 °C
Ambient temperature	Sensor	-20 ... 85 °C	-0 ... 75 °C
	Controller	0 ... 85 °C	-0 ... 75 °C
Storage temperature	Sensor	-40 ... 85 °C	
	Controller	-40 ... 85 °C	
Spectral range		7.9 μm	3.43 μm
Optical resolution		10:1	15:1
System accuracy <sup>1 2</sup>		±1.5 °C or ±1 % <sup>3 5</sup>	±3 °C or ±1 % <sup>3 5</sup>
Repeatability <sup>1</sup>		±0.5 °C or ±0.5 % <sup>3 5</sup>	±1.5 °C
Temperature coefficient <sup>5</sup>		±0.05 K/K or ±0.05 %/K (whichever is greater)	
Temperature resolution		0.5 K <sup>3</sup>	0.1 K
Response time (90 % signal)		150 ms	100 ms
Emissivity / gain		0.100 ... 1.100 (adjustable via programming keys or software)	
Transmissivity		0.100 ... 1.100 (adjustable via programming keys or software)	
Signal processing		Average, peak hold, valley hold (adjustable via programming keys or software); extended hold function with threshold and hysteresis	
Software (optional)		CompactConnect	

1) At ambient temperature 23 ±5 °C; whichever is greater (CTP-7)

2) Accuracy for thermocouple output: ±2.5 °C or ±1 %

3)  $\varepsilon = 1$  / Response time 1 s

4) With dynamic adaptation at low signal levels



5) For ambient temperatures (sensor): 18 °C ≤ sensor ≤ 28 °C

6) When CTP-3: Adjustable via programming keys or software

## 4. Delivery

### 4.1 Unpacking

- 1 thermoMETER CT sensor
- 1 Controller
- 1 Connection cable
- 1 Mounting nut
- 1 Instruction manual

-  Check the delivery for completeness and shipping damage immediately after unpacking.
-  In case of damage or missing parts, please contact the manufacturer or supplier.

Optional accessories you will find in the Chapters

- Mounting Accessories, [see A 1.1](#)
- Air Purge Collars, [see A 1.2](#)
- CF Lens and Protective Window, [see A 1.3](#)
- Further Accessories, [see A 1.4](#)

### 4.2 Storage

- Storage temperature, [see 3.5](#)
- Humidity: 10 ... 95 %, non-condensing

## 5. Optical Charts

The following optical charts show the diameter of the measuring spot in dependence on the distance between measuring object and sensor. The spot size refers to 90 % of the radiation energy. The distance is always measured from the front edge of the sensor.

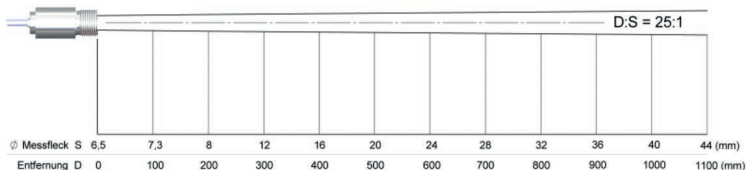
**i** The size of the measuring object and the optical resolution of the infrared thermometer determine the maximum distance between sensor and measuring object. In order to prevent measuring errors the object should fill out the field of view of the optics completely. Consequently, the spot should at all times have at least the same size as the object or should be smaller than that.

D = Distance from the front of the sensor to the object

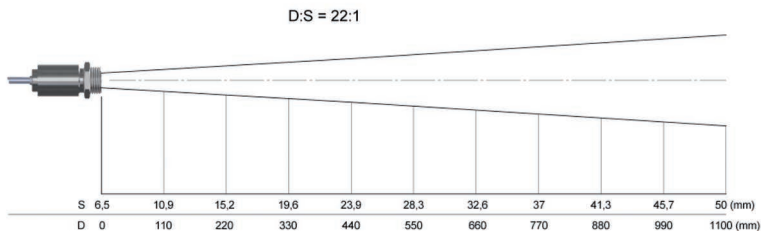
S = Spot size

The D:S ratio is valid for the focus point.

**CTF-SF25**  
**Optics: SF**  
**D:S: 25:1**

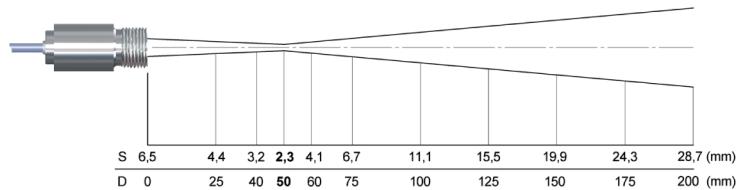


**CT-SF22**  
**Optics: SF**  
**D:S: 22:1**

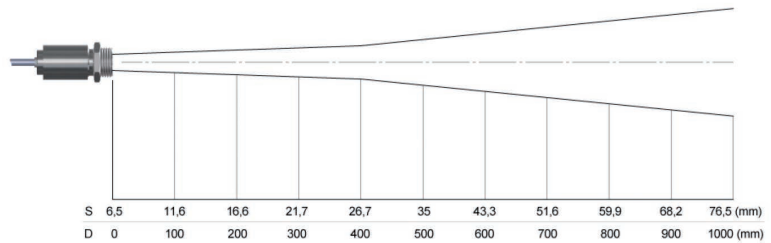


**CT-CF22**  
**Optics: CF integrated**  
**D:S: 22:1**

**2.3mm@ 50mm**  
**D:S (far field) = 6:1**

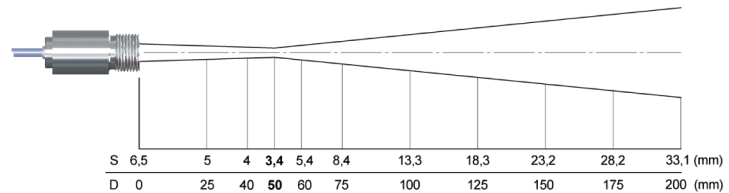


**CT-SF15**  
**CTF-SF15**  
**CTP-3**  
**Optics: SF**  
**D:S: 15:1**

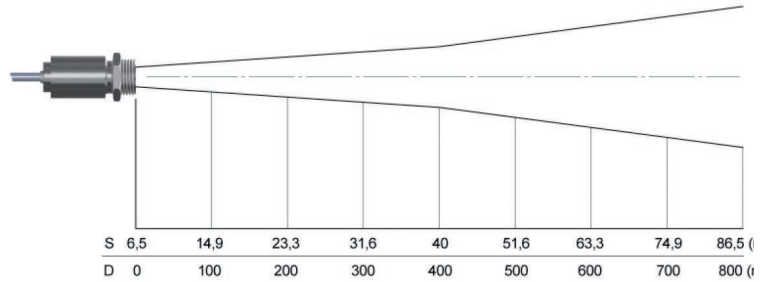


**CT-CF15**  
**Optics: CF integrated**  
**D:S: 15:1**

**3.0mm@ 50mm**  
**D:S (far field) = 5:1**

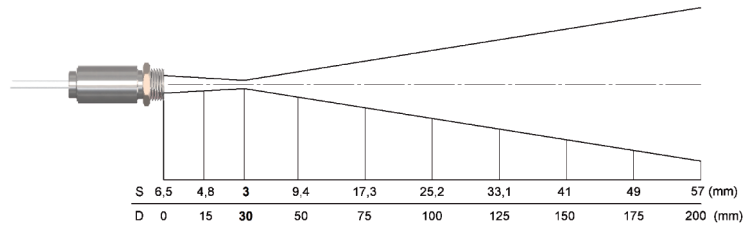


**CTH-SF10**  
**CTP-7**  
**Optics: SF**  
**D:S: 10:1**



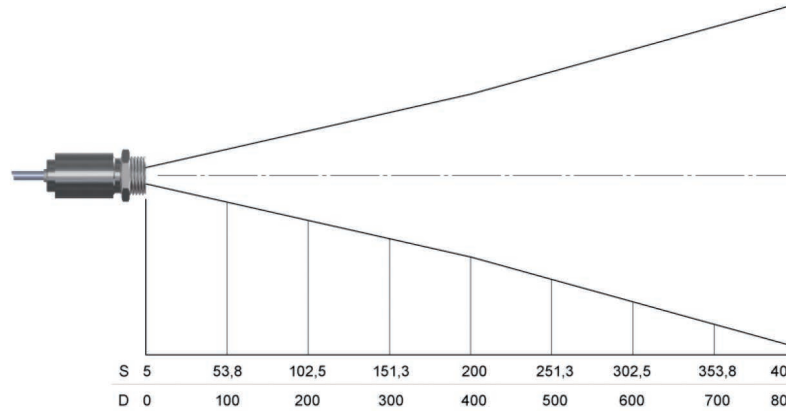
**CTH-CF10**  
**Optics: CF1 integrated**  
**D:S: 10:1**

**3.0mm@ 30mm**  
**D:S (far field) = 3:1**

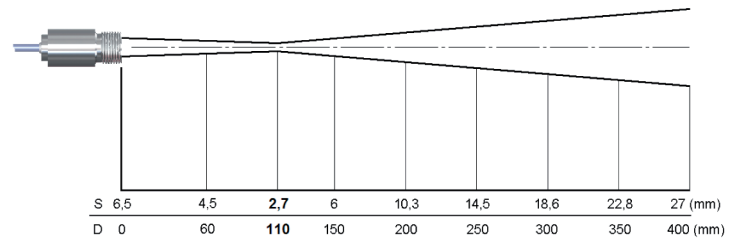




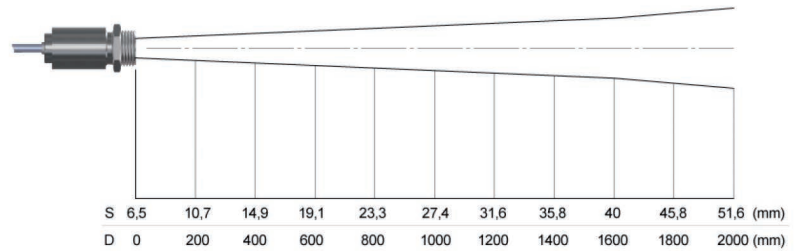
**CT-SF02**  
**CTH-SF02**  
**Optics: SF**  
**D:S: 2:1**



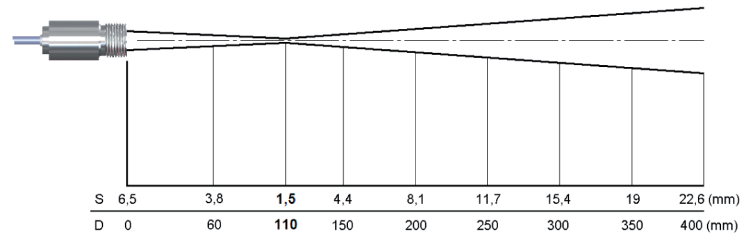
**CTM-1CF40**  
**CTM-2CF40**  
**Optics: CF integrated**  
**D:S: 40:1**  
**2.7mm@ 110mm**  
**D:S (far field) = 12:1**



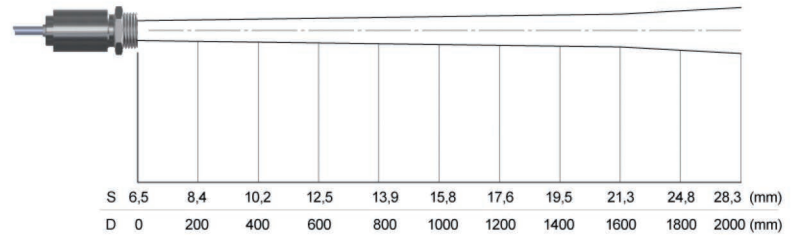
**CTM-1SF40**  
**CTM-2SF40**  
**Optics: SF**  
**D:S: 40:1**



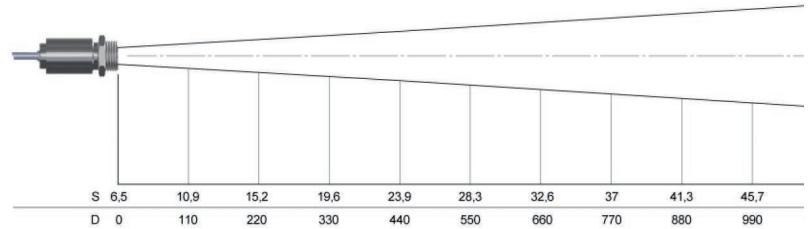
**CTM-1CF75**  
**CTM-1CF75H1**  
**CTM-2CF75**  
**CTM-2CF75H1**  
**CTM-3CF75H1**  
**CTM-3CF75H2**  
**CTM-3CF75H3**  
**Optics: CF integrated**  
**D:S: 75:1**  
**1.5mm@ 110mm**  
**D:S (far field) = 14:1**



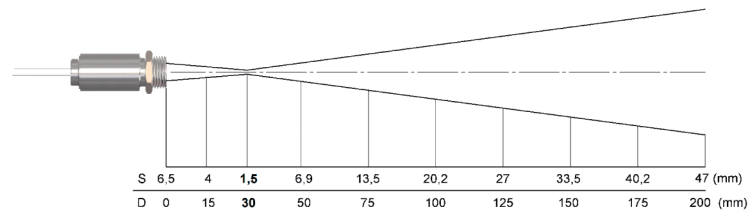
**CTM-1SF75**  
**CTM-1SF75H1**  
**CTM-2SF75**  
**CTM-2SF75H1**  
**CTM-3SF75H1**  
**CTM-3SF75H2**  
**CTM-3SF75H3**  
**Optics: SF**  
**D:S: 75:1**



**CTM-3SF22**  
**Optics: SF**  
**D:S: 22:1**

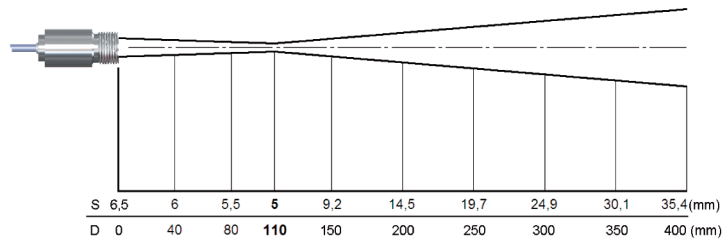


**CTM-3CF1-22**  
**Optics: CF1 integrated**  
**D:S: 22:1**  
  
**1.5mm@ 30mm**  
**D:S (far field) = 3.5:1**

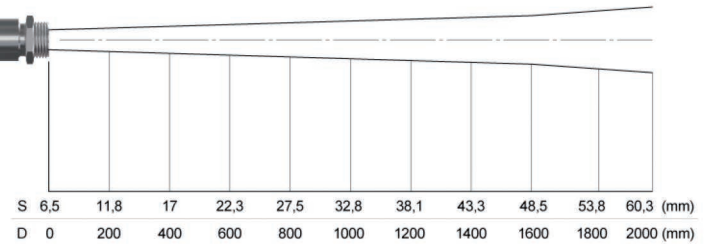


**CTM-3SF22**  
**Optics: CF**  
**D:S: 22:1**

**5mm@ 110mm**  
**D:S (far field) = 9:1**

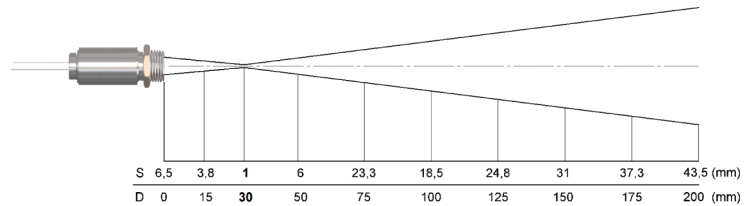


**CTM-3SF33**  
**Optics: SF**  
**D:S: 33:1**



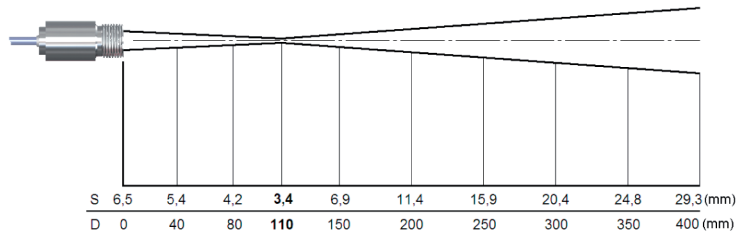
**CTM-3CF1-33**  
**Optics: CF1**  
**D:S: 33:1**

**1.0mm@ 30mm**  
**D:S (far field) = 4:1**



**CTM-3CF33**  
**Optics: CF**  
**D:S: 33:1**

**3.4mm@ 110mm**  
**D:S (far field) = 11:1**



## 6. Mechanical Installation

The thermoMETER CT sensors are equipped with a metrical M12x1-thread and can be installed either directly via the sensor thread or by means of the hex nut (included in scope of supply) to the mounting bracket available. Various mounting brackets which make the adjustment of the sensor easier can be ordered additionally as accessories.

The thermoMETER CTH and CTP sensors are delivered with massive housing and can be installed via the M18x1-thread, see Fig. 4.

**i** All accessories can be ordered using the according part numbers in brackets [ ].

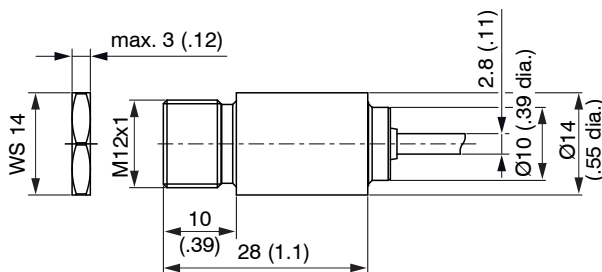


Fig. 2 Dimensional drawing sensor, dimensions in mm (inches), not to scale

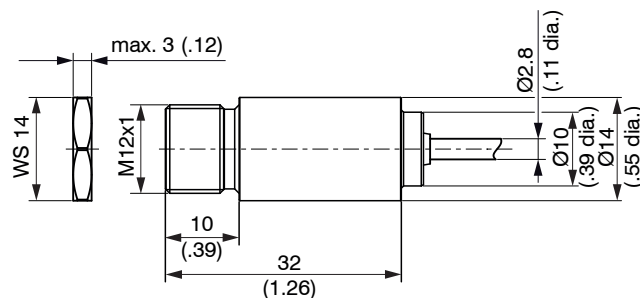
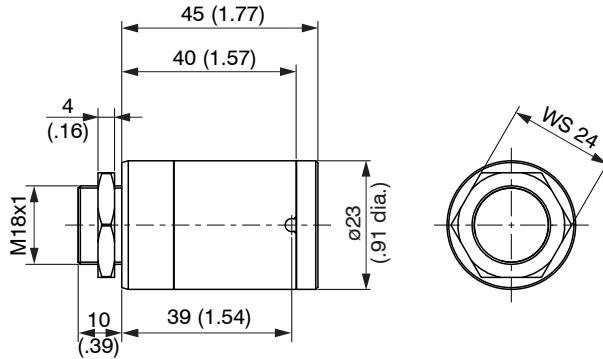


Fig. 3 Dimensional drawing sensor with integrated CF lens, dimensions in mm (inches), not to scale



**i** Make sure to keep the optical path clear of any objects.

*Fig. 4 Dimensional drawing massive housing (standard on CTH and CTP), dimensions in mm (inches), not to scale*

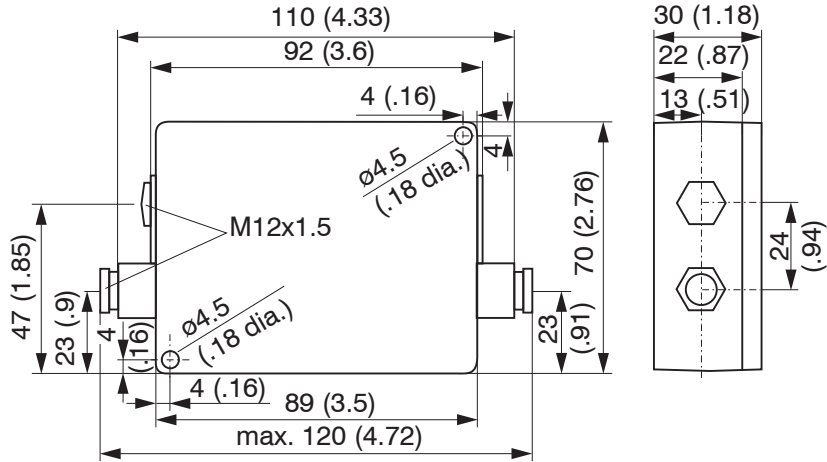


Fig. 5 Controller, dimensions in mm (inches), not to scale



Fig. 6 Controller with closed cover [TM-COV-CT]

The controller is also available with closed cover (no access to display and programming keys from outside) [TM-COV-CT], see Fig. 6.

- **I** On the CT-SF02, CTH-SF02 and CTH-SF10 models the sensor cable must not be moved during the measurement.



## 7. Electrical Installation

### 7.1 Cable Connections

➔ For the electrical installation of the thermoMETER CT, please open at first the cover of the controller (4 screws).

Below the display are screw terminals for the cable connection.

#### 7.1.1 Pin Assignment

##### 7.1.1.1 CT-SF02, CT-SF15, CT-SF22, CTF-SF15, CTF-SF25, CTH-SF02, CTH-SF10, CTP-7 and CTP-3 Models

PIN	Designation
+8 ... 36 VDC	Power supply
GND	Ground (0 V) of power supply
GND	Ground (0 V) of internal in- and outputs
OUT-AMB	Analog output sensor temperature (mV)
OUT-TC	Analog output thermocouple (J or K)
OUT-mV/mA	Analog output object temperature (mV or mA)
F1-F3	Functional inputs
AL2	Alarm 2 (Open-collector output)
3V SW	3 VDC, switchable for laser sighting tool
GND	Ground (0 V), for laser sighting tool
BROWN	Temperature probe sensor
WHITE	Temperature probe sensor
GREEN	Detector signal (-)
YELLOW	Detector signal (+)

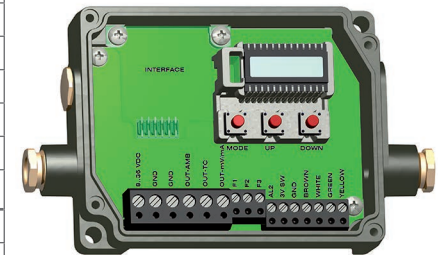
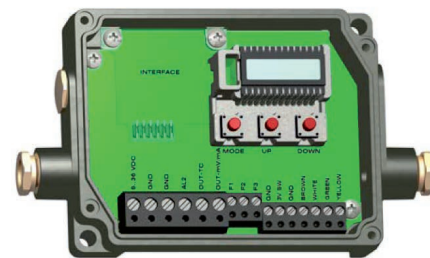


Fig. 7 Opened controller CT-SF02, CT-SF15, CT-SF22 | CTP-7 | CTF-SF15, CTF-SF25, CTH-SF02, CTH-SF10 with terminal connections

### 7.1.1.2 CTM-1, CTM-2, CTM-3 Models

PIN	Designation
+8 ... 36 VDC	Power supply
GND	Ground (0 V) of power supply
GND	Ground (0 V) of internal in- and outputs
AL2	Alarm 2 (Open collector output)
OUT-TC	Analog output thermocouple (J or K)
OUT-mV/mA	Analog output object temperature (mV or mA)
F1-F3	Functional inputs
GND	Ground (0 V)
3V SW	3 VDC, switchable, for laser sighting tool
GND	Ground (0 V) for laser sighting tool
BROWN	Temperature probe sensor (NTC)
WHITE	Sensor ground
GREEN	Sensor power
YELLOW	Detector signal



*Fig. 8 Opened controller (CTM-1, CTM-2, CTM-3) with terminal connections*

## 7.2 Power Supply

Please use a power supply unit with an output voltage of 8 - 36 VDC which can supply 100 mA. The ripple should be max. 200 mV.

### NOTICE

Please do never connect a supply voltage to the analog outputs.  
> Destruction of the output

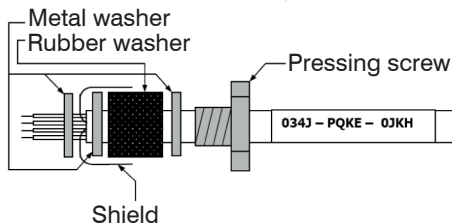
The thermoMETER CT is not a 2-wire sensor!

### 7.3 Cable Assembling

The cable gland M12x1.5 of the controller allows the use of cables with an outer diameter of 3 to 5 mm.

- ➡ Remove the isolation from the cable (40 mm power supply, 50 mm signal outputs, 60 mm functional inputs).
- ➡ Cut the shield down to approximately 5 mm and spread the strands out.
- ➡ Extract about 4 mm of the wire isolation and tin the wire ends.
- ➡ Place the pressing screw, the rubber washer and the metal washers of the cable gland one after the other onto the prepared cable end, [see Fig. 9](#).
- ➡ Spread the strands and fix the shield between two of the metal washers.
- ➡ Insert the cable into the cable gland until the limit stop.
- ➡ Screw the cap tight.

Every single wire may be connected to the appropriate screw clamps according to their colors.



*Fig. 9 Cable assembling*

- **i** Use shielded cables only!  
The sensor shield has to be grounded!

## 7.4 Ground Connection

### 7.4.1 CTM Models

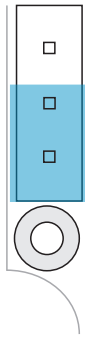
At the bottom side of the main board PCB you will find a connector (jumper), which has been placed from factory side as shown in the picture (lower and middle pin connected), see Fig. 10. In this position the ground connections (GND power supply/ outputs) are connected with the ground of the controller housing.

To avoid ground loops and related signal interferences in industrial environments it might be necessary to interrupt this connection.

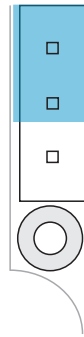
➡ Remove the board by loosening the two screws in order to switch the jumper on the back of the board.

➡ To do this, please put the jumper in the other position (middle and upper pin connected), see Fig. 11.

**i** If the thermocouple is used, the ground connection GND - housing should interrupted generally.



*Fig. 10 Plug connector (jumper),  
GND to housing; CTM models*



*Fig. 11 Plug connector (jumper),  
GND - open; CTM models*



Position  
cable gland

#### 7.4.2 CT-SF, CT-CF, CTF, CTH, CTP Models

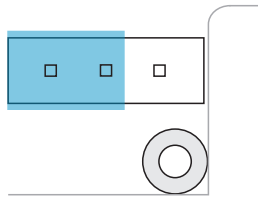
At the bottom side of the main board PCB you will find a connector (jumper), which has been placed from factory side as shown in the picture (lower and middle pin connected), see Fig. 12. In this position the ground connections (GND power supply/ outputs) are connected with the ground of the controller housing.

To avoid ground loops and related signal interferences in industrial environments it might be necessary to interrupt this connection.

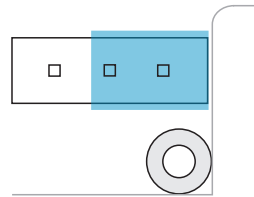
➡ Remove the board by loosening the two screws in order to switch the jumper on the back of the board.

➡ To do this, please put the jumper in the other position (middle and upper pin connected), see Fig. 13.

**i** If the thermocouple is used, the ground connection GND - Housing should generally be interrupted.



*Fig. 12 Plug connector (jumper),  
GND to housing;  
CT-SF, CT-CF, CTF, CTH, CTP models*



*Fig. 13 Plug connector (jumper),  
GND - open;  
CT-SF, CT-CF, CTF, CTH, CTP models*



Position  
cable gland

## 7.5 Exchange of the Sensor

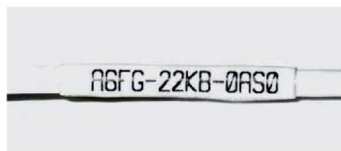
From factory side the sensor has already been connected to the controllers and the calibration code has been entered. Inside the model group CT-SF22, CT-SF15, CT-SF02, CTH-SF10, CTH-SF02 any exchange of sensors and controllers is possible. The sensors and controllers of the models CTF-SF15 and CTF-SF25 cannot be exchanged.

### 7.5.1 Entering of the Calibration Code




Every sensor has a specific calibration code, which is printed on the sensor cable. For a correct temperature measurement and functionality of the sensor this calibration code must be stored into the controller. The calibration code consists of 3 blocks (CTM-1, CTM-2, CTM-3 = 5 blocks) with 4 characters each.

Example: A6FG - 22KB - 0AS0  
                  block 1   block 2   block 3

**i** After exchanging a sensor the calibration code of the new sensor must be entered into the controller.



*Fig. 14 Calibration code*

➡ For entering the code, please press the  and  key (keep them pressed) and then the  key, see [Fig. 18](#).

The display shows `HCODE` and then the 4 signs of the first block. With  and  each sign can be changed.

➡ Please type in your specific calibration code of the sensor.

You can switch to the next sign or next block with . The entering of a new calibration code can also be made via the CompactConnect software (optional).

You will find the calibration code on a label fixed on the sensor cable (near the controller, [see Fig. 14](#)).

**i** Never remove this label respectively make sure that the code is noted somewhere. The code is needed if the controller has to be exchanged or in case of a necessary recalibration of the sensor.

After you have modified the sensor code, a reset is necessary to activate the change, [see 9](#).

### 7.5.2 Sensor Cable

On all CT models (exception CTM-3, CTP-7) the sensor cable can be shortened if necessary.

On the models CTM-1, CTM-2 and CTF the sensor cable can be shortened by max. 3 m.

A shortening of the cable will cause an additional measuring error of about 0.1 K/ m.

The CTM-3 models are supplied exclusively with a cable length of 3 m.

**i** On the CT models CT-SF02 / CTH-SF02 / CTH-SF10 the sensor cable must not be moved during the measurement.

## 8. Outputs and Inputs

### 8.1 Analog Outputs

The thermoMETER CT has one or two analog output channels.

Please do never connect a supply voltage to the analog outputs. The thermoMETER CT is not a 2-wire sensor!

> Destruction of output

**NOTICE**

#### 8.1.1 Output Channel 1

This output is used for the object temperature. The selection of the output signal can be done via the programming keys, [see 9](#). The CompactConnect software allows the programming of output channel 1 as an alarm output.

Output signal	Range	Connection pin on CT board
Voltage	0 ... 5 V	OUT-mV/mA
Voltage	0 ... 10 V	OUT-mV/mA
Current	0 ... 20 mA	OUT-mV/mA
Current	4 ... 20 mA	OUT-mV/mA
Thermo couple	TC J	OUT-TC
Thermo couple	TC K	OUT-TC

**i** According to the chosen output signal different connection pins on the main board are used (OUT-mV/mA or OUT-TC).

#### 8.1.2 Output Channel 2 (only CT-SF02, CT-SF15, CT-SF22, CTH, CTP-7 and CTP-3)

The connection pin OUT-AMB is used for output of the sensor temperature [-20 - 180 °C or -20 - 250 °C (on CTH-SF02 and CTH-SF10) as 0 - 5 V or 0 - 10 V signal]. The CompactConnect software allows the programming of output channel 2 as an alarm output. Instead of the sensor temperature THead also the object temperature TObj or controller temperature TBox can be selected as alarm source.



## 8.2 Digital Interfaces

All CT sensors can be optionally equipped with an USB-, RS232-, RS485-, Profibus DP-, CAN-Bus-, Modbus RTU- or Ethernet interface.

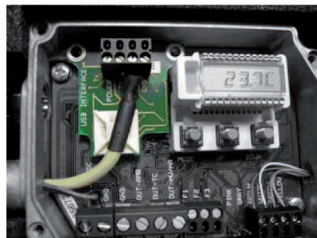
In the case that you want to use the delivered cable gland M12x1.5 for the interface cable, please disassemble the terminal block and assemble them again.

- ➡ To install, first remove the housing cover to get access to the interior of the housing.
- ➡ Now take the particular interface board and insert it into the slot provided in the controller.

The slot is located on the left side of the display, [see Fig. 15](#).

In the correct position the holes of the interface match with the thread holes of the controller.

- ➡ Now press the interface board down gently to connect it and use both M3x5 screws for fixing it in the controller housing.
- ➡ Plug the pre-assembled interface cable with the terminal block into the male connector of the interface board.



*Fig. 15 Interface board*

- ➡ Exchange the blind screw on the controller by the cable gland of the respective interface and install the appropriate interface cable.
- i** Please also pay attention to the additional notes for installing the respective interfaces, [see 8.2.1](#), [see 8.2.2](#) and the following interface chapters.

## 8.2.1 USB Interface

### 8.2.1.1 Installation

➡ Mount the USB adapter, [see 8.2](#).

•  
1 Make sure the wiring is correct according to the wire colors printed on the interface board.

For industrial installations it is recommended to connect the shield of the USB adapter cable with the controller housing (inside the cable gland).

The CT does not need external power supply for operation – it will be powered by the USB interface.

If an external power supply has already been installed, this will not affect the functionality of the CT.

### 8.2.1.2 Driver Installation of Interface

➡ Please install the CompactConnect software, [see 11](#).

➡ Now please press the button `Install Adapter driver`.

All necessary device drivers will be installed. After connecting new sensors or new USB adapter cables to your PC the system will automatically allocate them to the correct driver. If the `Found New Hardware Wizard` appears you can select `Connect to Windows Update` or `Install the Software automatically`.

After you have connected the USB-cable to your PC and started the CompactConnect software the communication will be established. If the recognition is not automatic, you will find the drivers on the Compact Connect Software CD in the path `\Driver \ Infrared Sensor Adapter`.

## 8.2.2 RS232 Interface

### 8.2.2.1 Installation

➡ Mount the RS232 adapter, [see 8.2.](#)

• **i** Make sure the wiring is correct according to the drawing and designation printed on the interface board, [see 13.](#)

The CT always needs an external power supply for operation.

### 8.2.2.2 Software Installation

➡ Please install the CompactConnect software, [see 11.](#)

➡ Follow the software instruction manual on the delivered CompactConnect software CD.

After you have connected the RS232 cable to your PC and started the CompactConnect software the communication will be established.

The setting for baud rate in the CompactConnect software must be the same as on the thermoMETER CT unit (factory default: 9.6 kBaud).

• **i** Please make sure that the option `Scan non-USB devices` in menu `Preferences/Options` is activated in the CompactConnect software.

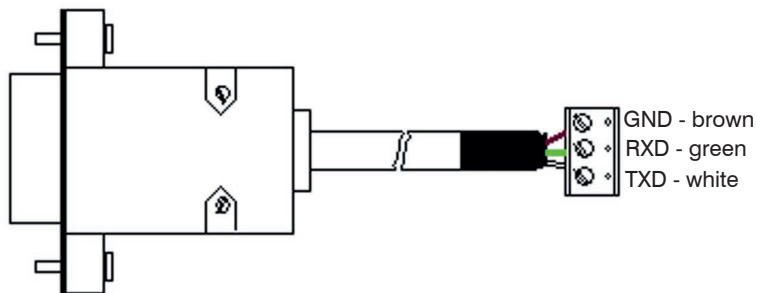


Fig. 16 Pin assignment RS232

## 8.2.3 RS485 Interface

### 8.2.3.1 Installation

➡ Mount the RS485 adapter, [see 8.2.](#)

The RS485-USB adapter is providing a 2-wire half-duplex mode.

➡ Please connect terminal A of the interface with terminal A of the next RS485 interface and so on, [see Fig. 17.](#) With the B terminal proceed as well.

**i** Make sure that you always connect A to A and B to B, not reverse.

You may run up to 32 CT units on one RS485-USB adapter.

➡ Turn the 120R-switch to ON only at one of the connected CT units.

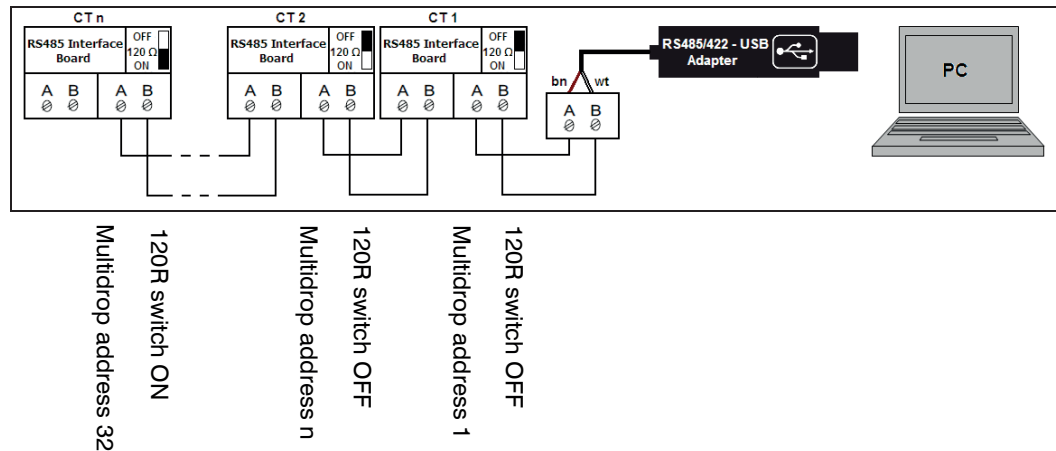


Fig. 17 Pin assignment RS485

### 8.2.3.2 Sensor Installation

Each CT unit connected to the RS485 needs a different multidrop address (1 ... 32).

➡ Please adjust the address by pressing the  button until M xx appears in the display.

Using the Up and Down keys you can change the shown address (xx) The address can also be changed with the CompactConnect software. The baud rate setting in the CompactConnect software must be the same as on the CT unit (factory default: 9.6 kBaud.)

➡ Please install the CompactConnect software, [see 11](#).

➡ Please connect the RS485 USB adapter (TM-RS485USBK-CT) via the supplied USB cable with your PC.

After it has been connected the computer will recognize a new USB device and (if connected the first time) will ask for installation of the according driver software.

➡ Please select `Search` and install the RS485 adapter USB driver from the CompactConnect software CD.

## 8.2.4 Profibus Interface

### 8.2.4.1 Installation

➡ Mount the Profibus adapter, see Chap. 7.2.

**i** Make sure the wiring is correct, see Fig. 14.

**i** We recommend for industrial installations to connect the shield of the Profibus cable with the controller housing (inside the cable gland).

The thermoMETER CT always needs an external power supply.

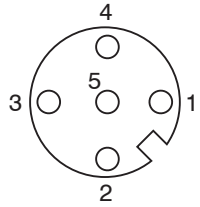
Connector	Color	Function	Pin	
A	Green	A	2	
B	Red	B	4	
GND	Blue	Ground	3	
VCC	Brown	+5 V (not used)	1	
Shield	n.c.		5	
Housing	Silver (shield)			

Fig. 18 Pin assignment Profibus interface

1) Standard M12 Profibus round connector

### 8.2.4.2 Commissioning Profibus

- Read in the „IT010A90.gsd“ GSD file, contained on the delivered CompactConnect software CD, into the PLC configuration tool and configure the controller.

At least one module must be selected. You will find more information about the Profibus interface on the enclosed CompactConnect software CD, page 18.

- Open the controller and connect the power supply, see Fig. 19.

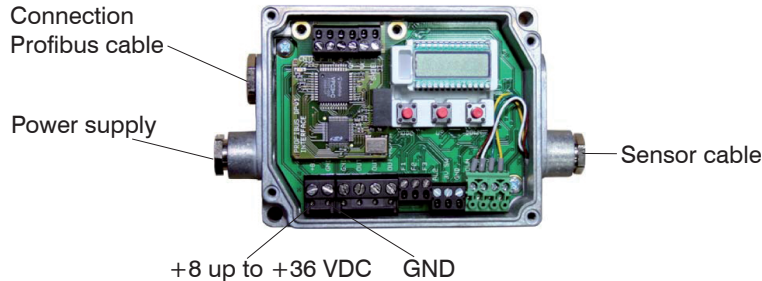


Fig. 19 Commissioning Profibus

- Switch on the power supply.
- Press the Mode button 18 times until the item `SL001` appears. Set the slave address with the `UP` and `DOWN` buttons. Valid slave addresses start with 001 up to 125. Use the same address as in the PLC configuration tool, see the Profibus instruction manual on page 4, 6 on CompactConnect Software CD.
- Switch off the controller for at least 3 seconds by interrupting the power supply.
- Connect the connector of the Profibus cable with a Profibus port. Take care on the terminating resistor of the Profibus.


The controller with DPv1 Profibus is now ready for data exchange with the Profibus master; see the Profibus instruction manual on page 7 on CompactConnect Software CD.


The measuring values are displayed in hex format and must be converted into decimals; see the Profibus instruction manual on page 7 on CompactConnect Software CD.

The settings of the DPv1 Profibus interface and the communication with the Profibus master are described in the Profibus instruction manual on CompactConnect Software CD.

### 8.2.5 CAN BUS Interface

 Mount the CAN BUS adapter, [see 8.2](#).

 Make sure the wiring is correct, [see Fig. 18](#).

 We recommend for industrial installations to connect the shield of the CAN BUS cable with the controller housing (inside the cable gland).

The thermoMETER CT always needs an external power supply.

#### **CAN Protocol**

CAN open (see documentation on CompactConnect software CD)

#### **Wiring**

CAN Bus:

CAN\_H on terminal „H“

CAN\_L on terminal „L“

Analog signal:

Black cord on terminal „GND“

Red cord on terminal „OUT-mV“

The controller contains additional terminals to connect other devices (power supply, CAN bus, terminating resistor).

#### **CAN module factory settings**

Module address: 20 (14 H)

Baud rate: 250 kBaud

Analog input: 0 ... 10 V

Temperature range: 0 ... 60 °C (2 decimal places)

Emission ratio: 0.970

 The settings for “Analog output 0 ... 10 V“ and “Temperature range 0 ... 60 °C“ on the CT sensor must be identical with the CAN bus module values.



### Factory settings address and baud rate

CAN open service „LSS / Layer Setting Services“

Index temperature value:

The temperature information is located in the object register 7130h (Sub01):

e.g. B4: LB B5: HB

B4: DA B5: 07 T = 20.10 °C

Before delivery, MICRO-EPSILON can set parameters, desired by the customer, for an extra charge. For the subsequent conversion a CAN master is required.

### Diagnosis

If the power supply is on, the LED displays one of the following conditions:

State	Meaning
Flashes quickly	Device is in preoperational-mode.
Off	Power supply is not correct / faulty hardware.
Illuminates	Device is in operational mode.
Sparkles	Device is stopped. = Communication stopped.

## 8.2.6 Modbus RTU

### 8.2.6.1 Serial Interface Parameters

Baud rate: 9600 or 19200, set by user (factory default: 9600)

Data bits: 8

Parity: even

Stop bits: 2

Flow control: off

### 8.2.6.2 Protocol

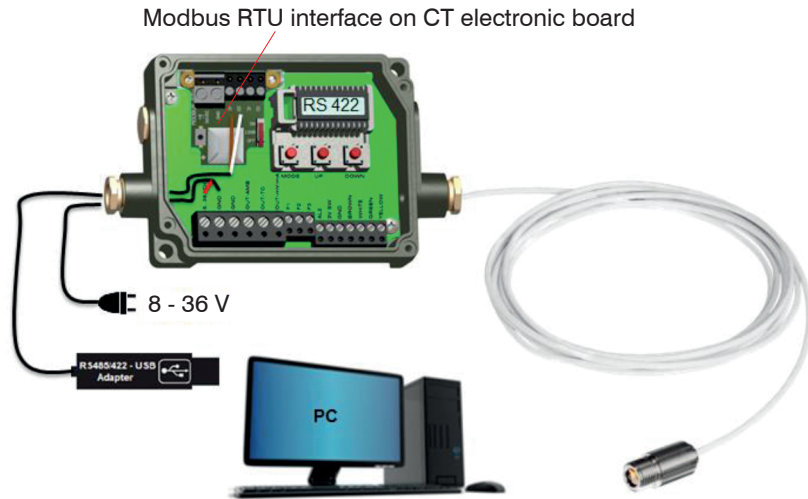
The protocol is a Modbus RTU protocol.

### 8.2.6.3 Installation Overview

- ➡ Insert the Modbus RTU interface on the CT electronic board and power it with 8 - 36 V.
- ➡ Select the RS422 mode on the controller.



*Fig. 20 Modbus RTU interface*



*Fig. 21 Installation Modbus RTU interface on thermoMETER CT electronic board*

➡ Use a Modbus RTU program to read out the data, see Fig. 22.

This is done via the Read Holding Registers and Read Input Registers, see Fig. 23.

Connection type: Serial

Comm port: COM65

Parity: Even

Stop bits: Two

Baud rate: 9600

Byte size: 8

Mode: Rtu

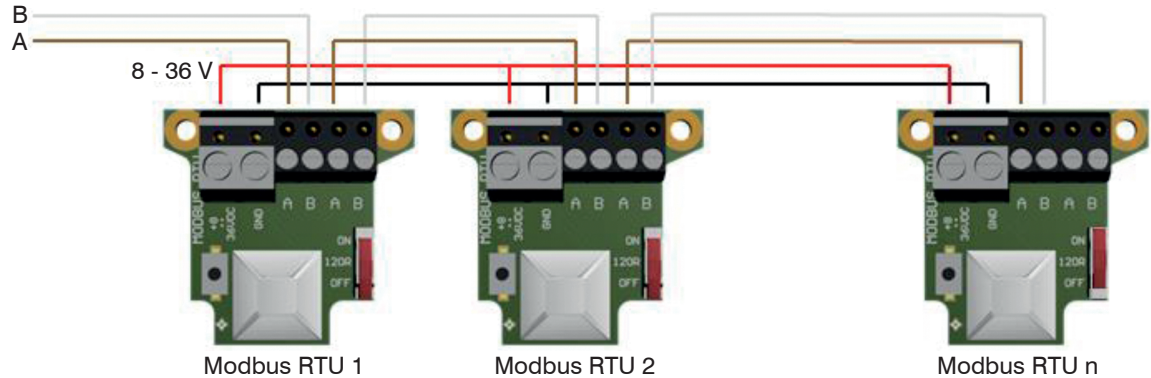
Byte order: 4321

Fig. 22 View Modbus RTU program

- 03 Read Holding Registers
- 01 Read Coils
- 02 Read Discrete Inputs
- 03 Read Holding Registers
- 04 Read Input Registers
- 05 Write Single Coil
- 06 Write Single Register
- 08 Diagnostics
- 15 Write Multiple Coils
- 16 Write Holding Registers

Fig. 23 View dropdown menu Modbus RTU program

### 8.2.6.4 Connection of More than one Device (Synchronisation)



➔ Turn the 120R switch to ON for the last connected CT unit.

**i** For the assignment of the Modbus ID of the individual devices, the devices must be connected one after the other.

By default the Modbus ID is for every device 1.

In order to communicate, each device needs its own ID. The numbers 1 to 247 can be selected.

### 8.2.6.5 Overview of Digital Commands for Modbus RTU Digital Interfaces for CT and CTLaser Sensors

The command overview is available online on the product side of the sensor at:

<https://www.micro-epsilon.de/download/manuals/man--thermoMETER-ct-ctlaser-modbus-rtu-commands--en.pdf>

## 8.2.7 Ethernet Interface

### 8.2.7.1 Installation

- Mount the Ethernet adapter, [see 8.2](#).
- In case you want to run the pre-mounted cable of the Ethernet box through the delivered cable gland, the terminal block has to be disassembled/assembled.

The thermoMETER CT always requires an external power supply of at least 12 V.

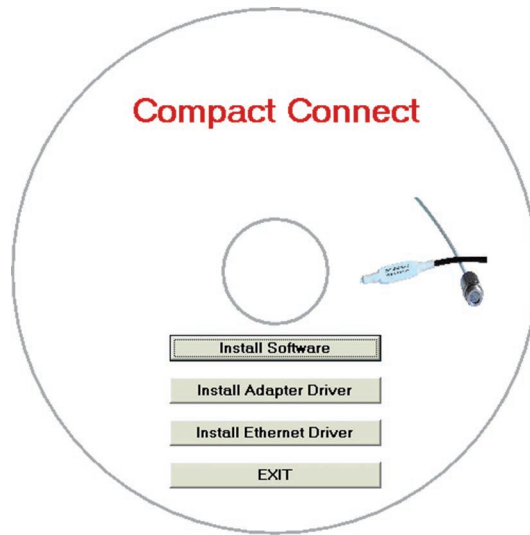
**i** Make sure the wiring is correct according to the colors printed on the interface board.

- Please connect the shield of the cable with the controller housing (inside the cable gland).
- Please connect the Ethernet adapter device with your network using an Ethernet cable.

### 8.2.7.2 Installation of the Ethernet Adapter in a Network

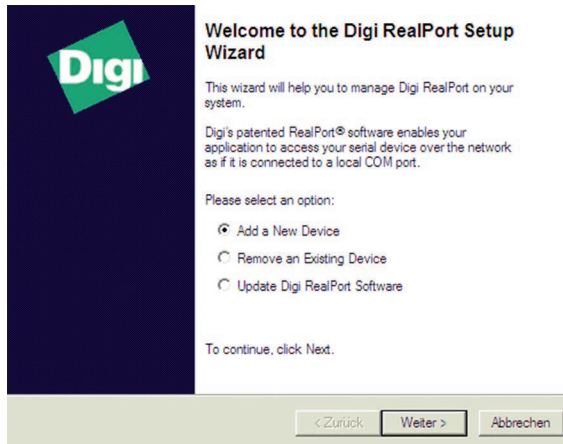
- First connect the PC to the Internet.
- Please install the CompactConnect software CD, [see 11](#).

If the autorun option is activated the installation wizard will start automatically. Otherwise please start CDset-up.exe from the CompactConnect software CD. The following screen will appear, [see Fig. 24](#).

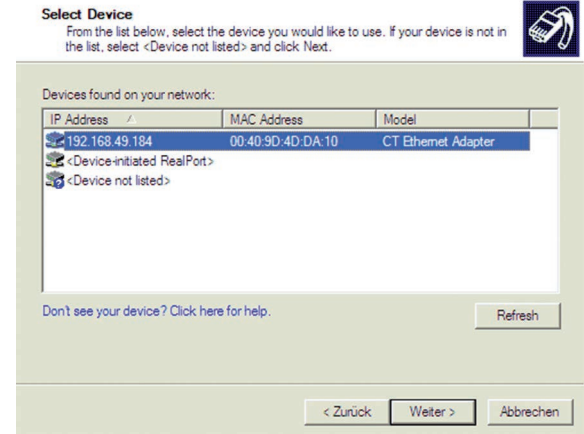


*Fig. 24 View CompactConnect CD-ROM*

➡ Now install the device driver by selecting `Install Ethernet Driver`.



➔ Select Add New Device and press Weiter.




The IP and MAC address of the Ethernet adapter will appear in the list. You will find the MAC address also printed on the Ethernet adapter.

➔ Please mark the adapter in the list and press Weiter.



**Describe the Device**  
Enter information for the device you would like to use.



Device Model Name:  
CT Ethernet Adapter

Network Settings  
 IP  MAC  DNS  TCP-L  
192 . 168 . 49 . 184

Default Network Profile:  
TCP: Typical Settings

RealPort TCP: 771 Serial UDP: 2101

Wait for COM open request

COM Port Settings  
No. Ports: 1  
Starting COM: COM97

Skip Modem PnP

Device Features  
 Encryption  
 Authentication


Install Options...  
Help

< Zurück Fertig stellen Abbrechen

The following screen shows all settings.

➡ Please press **Fertig stellen**.

**Installing Digi RealPort**  
Please wait while your Digi RealPort device is installed.



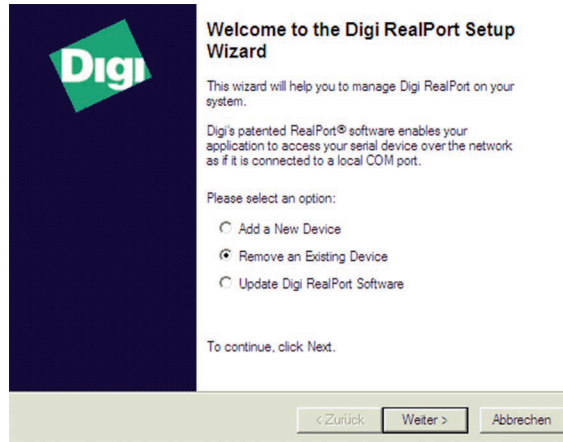
Installing Multiport Serial device

Progress bar: 100% (10 blue segments)

< Zurück Fertig stellen Abbrechen

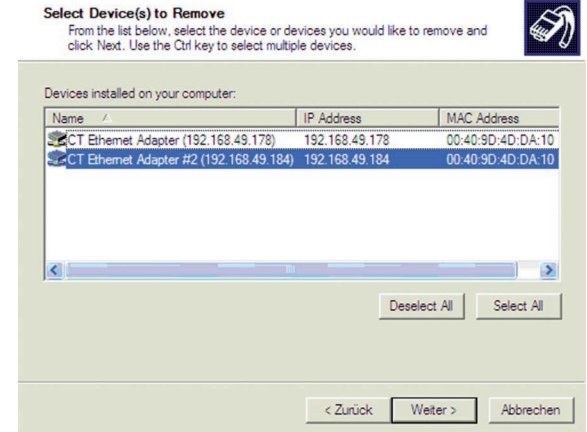
The device will be installed inside the network.

### 8.2.7.3 Uninstalling the Ethernet Adapter in a Network



To deinstall an adapter please follow the steps described under Network Installation, [see 8.2.7.2](#).

➡ Select Remove an Existing Device and press then Weiter.



In the upper overview all on the PC installed Ethernet adapter are shown.

➡ Select the adapter(s) which should be deinstalled and press Weiter.

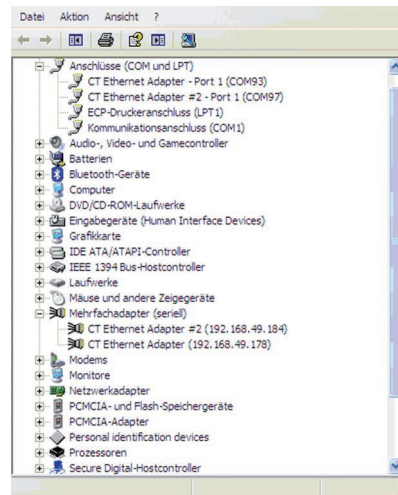
### 8.2.7.4 Direct Connection to a PC

If a direct connection between Ethernet adapter and PC is required both have to be connected via a cross-over cable. In addition the adapter and the PC need to get a fixed IP address.

➡ Please open the Windows device manager after the network installation (Start/Control panel/System/Hardware/Device manager).

➡ Please choose Mehrfachadapter/Multi adapter (serial) from the list.

By double clicking the desired Ethernet adapter, a properties window is opening.

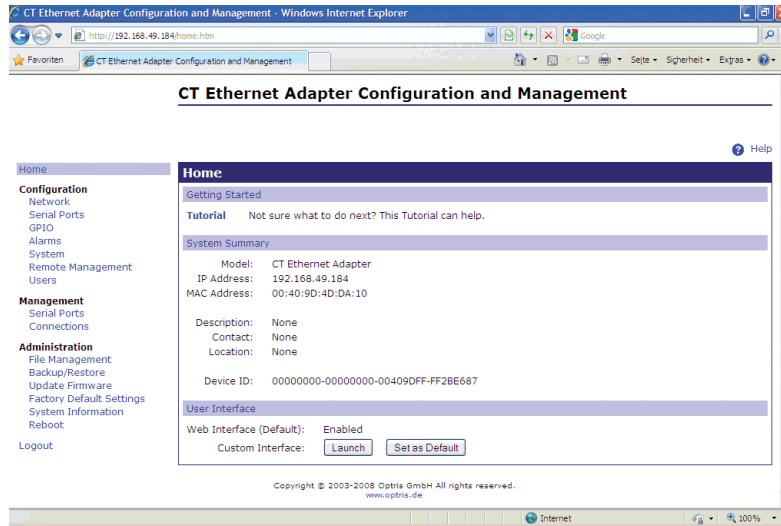


➡ Please open the tab Advanced in this window. Beside Device UI you will find a link with the network IP address.

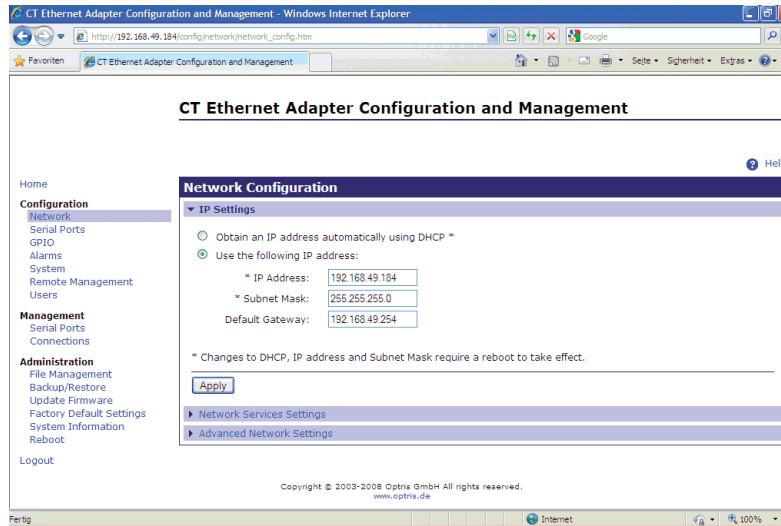


By clicking on the link the configuration page for the Ethernet adapter will be opened in your web browser.

➡ Please select Network (Navigation left; below configuration).



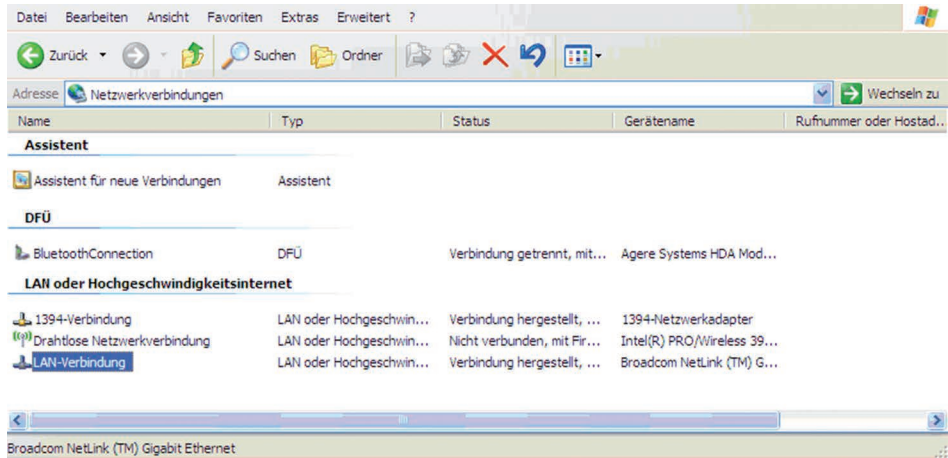
In the input mask Use the following IP address below you can now enter a fixed IP address.



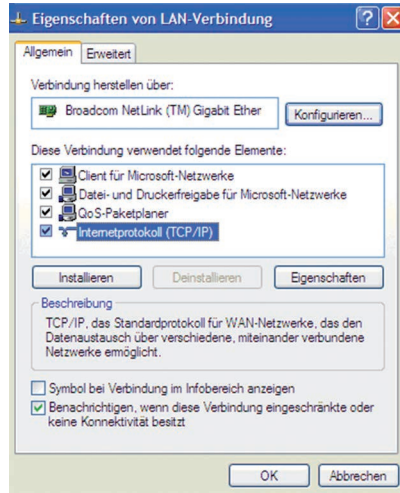
➡ Confirm your settings with `Apply`.

For a communication with the adapter you now have to configure the network settings on your PC.

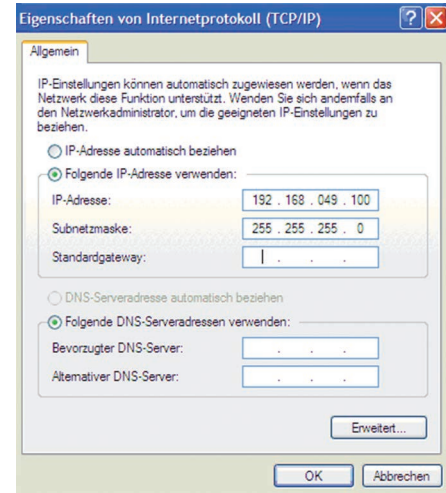
➡ Please open the LAN settings (Start/Control panel/Network settings/Settings).



➡ Mark the LAN connection and open the properties window using the right mouse button.



➔ Double click on Internetprotokoll/Internet protocol (TCP/IP).



➔ Please enter here a fixed IP address for the PC.

**i** Please note that the first three blocks (example: 192.168.049) have to match with the IP address of the adapter device.

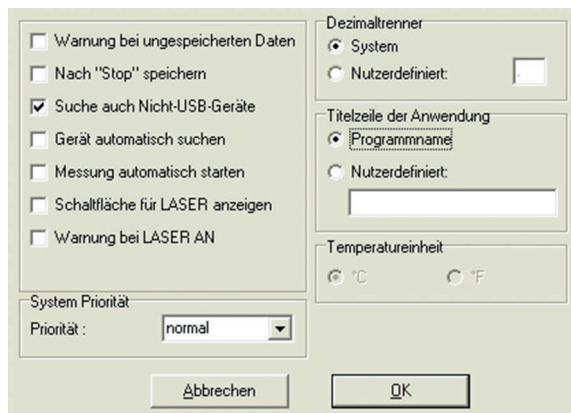
➔ Press OK.

The installation is finished.

### 8.2.7.5 Settings inside the CompactConnect Software

After a successful network installation of the Ethernet adapter you can start the CompactConnect software.

To make sure that an available device can be found you should first activate the function `Scan non-USB devices` in the menu point `Preferences/Options`:



Furthermore you should set the `Communication` mode to `Standard` (menu: `Measurement/Settings`).

This activates the so called polling mode <sup>1</sup> (bi-directional communication).



1) Polling Mode = Method, to determine the status of a device consisting of hardware or software or the event of a change of values by cyclic queries.



### 8.2.7.7 Resetting the Ethernet Adapter

The Ethernet adapter can be reset to the factory setting.



Please use a ballpoint pen to press the `Reset` button (hole at the top of the housing).



Switch on the power supply while pressing the `Reset` button.

After a few seconds you will see a flashing green LED (network connection).



Please wait until the green LED flashes with a 1-5-1<sup>1</sup> pattern, then you can release the `Reset` button.



Wait until the adapter boots again.

The configuration is reset to factory setting during this time.

The configuration is not reset, if you switch off the adapter before you release the `Reset` button.

The adapter will show an undefined configuration<sup>2</sup>, if you switch off the adapter briefly after you have released the `Reset` button.

The adapter works in the DHCP mode after resetting.

If you want to make a direct connection to a PC, see [8.2.7.4](#).

- 1) Flashing - break - 5 x flashing - break - flashing
- 2) If necessary only some values are reset.

### 8.3 Relays Outputs

The thermoMETER CT can optionally be equipped with a relay output. The relay board is installed the same way as the digital interfaces, [see 8.2](#).

➡ Connect the external electrical circuit with the terminal blocks.

A simultaneous installation of a digital interface and the relay outputs is not possible.

The switching thresholds correspondent with the values for alarm 1 and 2, [see 8.5](#), [see 3.5.2](#), and are factory-set, [see A 2](#).

Alarm 1 = 30 °C/ norm. Closed (Low-Alarm) and Alarm 2 = 100 °C/ norm. open (High-Alarm).

The adjustment of the alarms can result from the modification of the alarm 1 and alarm 2 via the programming keys.

To make advanced settings (change of low- and high alarm) a digital interface (USB, RS232) and the CompactConnect software is needed.

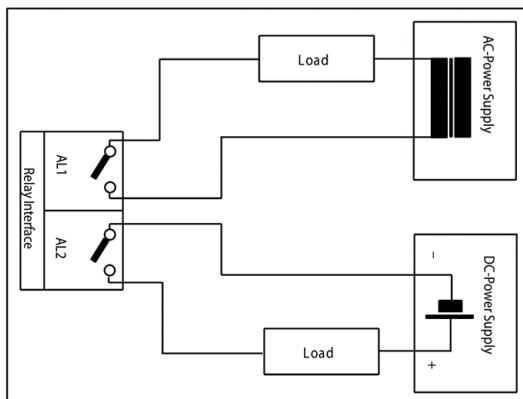


Fig. 25 Relay interface with pin assignment

## 8.4 Functional Inputs

The three functional inputs F1 - F3 can be programmed with the CompactConnect software, only.

F1 (digital)	Trigger (a 0 V - level on F1 resets the hold functions)
F2 (analog)	External emissivity adjustment [0 - 10 V: 0 V ► $\epsilon = 0.1$ ; 9 V ► $\epsilon = 1$ ; 10 V ► $\epsilon = 1.1$ ]
F3 (analog)	External compensation of ambient temperature/the range is scalable via CompactConnect software [0 - 10 V: ► -40 - 900 °C/preset range: -20 - 200 °C]
F1 - F3 (digital)	Emissivity (digital choice via table) A non-connected input represents: F1 = High F2, F3 = Low High-level: $\geq +3 \text{ V} \dots +36 \text{ V}$ Low-level: $\leq +0.4 \text{ V} \dots -36 \text{ V}$

## 8.5 Alarms

The thermoMETER CT has following alarm features:

All alarms (alarm 1, alarm 2, output channel 1 and 2 if used as alarm output) have a fixed hysteresis of 2 K (C<sub>Hot</sub>: 1 K).

### 8.5.1 Output Channel 1 and 2 (Channel 2 on CT-SF / CTP-7 and CTP-3)

The respective output channel has to be switched into digital mode for activation. For this the CompactConnect software is required.

### 8.5.2 Visual Alarms

These alarms will cause a change of color of the LCD display and will also change the status of the optional relays interface. In addition, Alarm 2 can be used as open collector output at pin AL2 on the controller [24 V/ 50 mA].

The alarms are factory-set as follows:

Alarm 1	Norm. closed/Low-Alarm
Alarm 2	Norm. open/High-Alarm

Both of these alarms will have effect on the LCD color:

BLUE	Alarm 1 active
RED	Alarm 2 active
GREEN	No alarm active

For extended setup like definition as low or high alarm (via change of normally open/closed), selection of the signal source (T<sub>Obj</sub>, T<sub>Head</sub>, T<sub>Box</sub>) a digital interface (e.g. USB, RS232) including the CompactConnect software is needed.

### 8.5.3 Open Collector Output / AL2

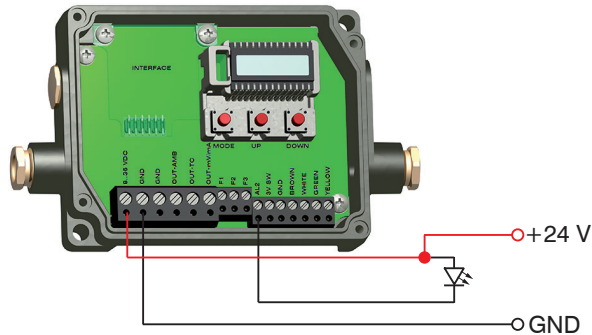


Fig. 26 Open collector output / AL2

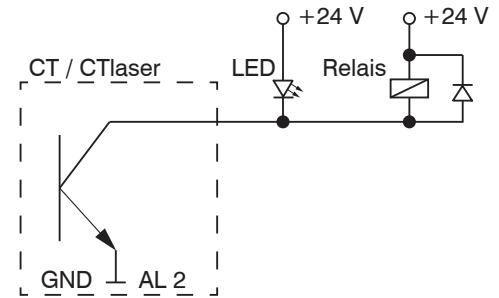


Fig. 27 Open collector output / AL2 circuit diagram

- i** The transistor acts as a switch. In case of alarm, the contact is closed.
- A load/consumer (relay, LED or a resistor) must always be connected.
- The alarm voltage (here 24 V) must not be connected directly to the alarm output (short circuit).



**NOTICE**

Avoid exceeding the maximum load of 50 mA on the output.  
 > Destruction of the output

## 9. Operating




After powering up the supply voltage the sensor starts an initializing routine for some seconds. During this time the display will show `INIT`. After this procedure the object temperature is shown in the display. The display backlight color changes according to the alarm settings, [see 8.5](#), [see 8.5.2](#).

### 9.1 Restoring Factory Setting

➡ To set the thermoMETER CT back to the factory settings, please first press the  and then the  button and keep both pressed for approximately 3 seconds.

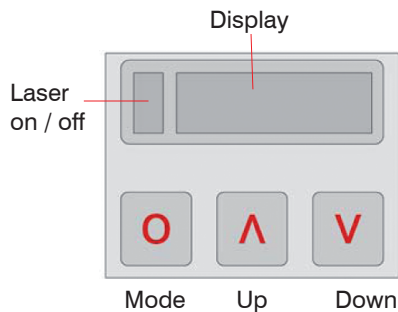
The display will show `RESET` for confirmation.

Display	Modes [Sample]	Adjustment Range
142.3C	Object temperature (after signal processing) [142.3 °C]	Fixed
127CH	Sensor temperature [127 °C]	Fixed
25CB	Box temperature	Fixed
142CA	Current object temperature	Fixed
<input type="checkbox"/> MV5	Signal output channel 1 [0 - 5 V]	<input type="checkbox"/> 0 - 20 = 0 - 20 mA/ <input type="checkbox"/> 4 - 20 = 4 - 20 mA/ <input type="checkbox"/> MV5 = 0 - 5 V/ <input type="checkbox"/> MV10 = 0 - 10 V/ <input type="checkbox"/> TCJ = Thermocouple type J/ <input type="checkbox"/> TCK = Thermocouple type K
E0.970	Emissivity [0.970]	0.100 ... 1.100
T1.000	Transmissivity [1.000]	0.100 ... 1.100
A 0.2	Signal Output Average [0.2 s]	A---- = inactive/ 0.1 ... 999.9 s

Display	Mode [Sample]	Adjustment range
P----	Signal output peak hold [inactive]	P---- = inactive / 0.1 ... 999.9 s / P ∞ ∞ ∞ ∞ = infinite
V----	Signal output valley hold [inactive]	V---- = inactive / 0.1 ... 999.9 s / V ∞ ∞ ∞ ∞ = infinite
u 0.0	Lower limit temperature range [0 °C]	Depending on model / inactive at TCJ and TCK output
n 500.0	Upper limit temperature range [500 °C]	Depending on model / inactive at TCJ- and TCK-output
[ 0.00	Lower limit signal output [0 V]	According to the range of the selected output
] 5.00	Upper limit signal output [5 V]	According to the range of the selected output
U °C	Temperature unit [°C]	°C/°F
/ 30.0	Lower alarm limit [30 °C]	Depending on model
// 100.0	Upper alarm limit [100 °C]	Depending on model
XHEAD	Ambient temperature compensation [Sensor temperature]	XHEAD = sensor temperature/-40.0 ... 900.0 °C (for CT-SF) as fixed value for compensation/ returning to XHEAD (sensor temperature) by pressing  and  together
M 01	Multidrop address [1] (only with RS485 interface) RS422 mode	01 ... 32, RS422 (Press  button on M 01)
B 9.6	Baud rate in kBaud [9.6]	9.6/19.2/38.4/57.6/115.2 kBaud
S ON	Laser eyepiece (3 VDC-switches to the connection pin „3 VSW“)	ON/OFF; This menu item appears on the models CTM-1, CTM-2, CTM-3 on first position.

## 9.2 Sensor Setup

The programming keys **O**, **^** and **v** enable the user to set the sensor on-site. The current measuring value or the chosen feature is displayed. With **O** the operator obtains the chosen feature, with **^** and **v** the functional parameters can be selected – a change of parameters will have immediate effect. If no key is pressed for more than 10 seconds the display automatically shows the calculated object temperature (according to the signal processing).







*Fig. 28 Display and programming keys*

Pressing the **O** button again recalls the last called function on the display. The signal processing features peak hold and valley hold cannot be selected simultaneously.



### 9.3 Explanation to the Menu Items

Display	Description
□ MV5	Selection of the output signal. By pressing  or  the different output signals can be selected, <a href="#">see 9.1</a> .
EO.970	Setup of emissivity. Pressing  increases the value;  decreases the value (also valid for all further functions). The emissivity ( $\epsilon$ - Epsilon) is a material constant factor to describe the ability of the body to emit infrared energy, <a href="#">see 14</a> .
T1.000	Setup of transmissivity. This function is used if an optical component (protective window, additional optics e.g.) is mounted between sensor and object. The standard setting is 1.000 = 100 % (if no protective window etc. is used).
A 0.2	Setup of average time. In this mode an arithmetic algorithm will be performed to smoothen the signal. The set time is the time constant. This function can be combined with all other post processing functions. On CTM-1, CTM-2, CTM-3 models the shortest value is 0.001 s (other models: 0.1 s) and can be only increased/decreased by values of the power series of 2 (0.002, 0.004, 0.008, 0.016, 0.032, ...). If the value is set to 0.0 the display will show --- (function deactivated).
P----	Setup of peak hold. In this mode the sensor is waiting for descending signals. If the signal descends the algorithm maintains the previous signal peak for the specified time. After the hold time the signal will drop down to the second highest value or will descend by 1/8 of the difference between the previous peak and the minimum value during the hold time. This value will be held again for the specified time. After this the signal will drop down with slow time constant and will follow the current object temperature. If the value is set to 0.0 the display will show --- (function deactivated).
V----	Setup of valley hold. In this mode the sensor waits for ascending signals. The definition of the algorithm is equal to the peak hold algorithm (inverted). If the value is set to 0.0 the display will show --- (function deactivated).

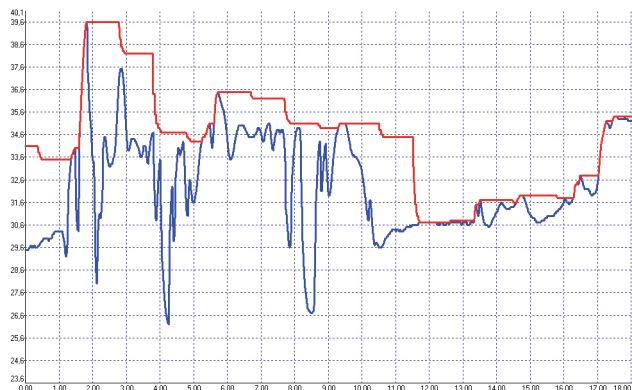







Fig. 29 Signal graphs with P--

Red graph TProcess with peak hold (hold time = 1 s)

Blue graph TActual without post processing

Display	Description
u 0.0	Setup of the lower limit of temperature range. The minimum difference between lower and upper limit is 20 K. If you set the lower limit to a value $\geq$ upper limit, the upper limit will be adjusted to [lower limit + 20 K] automatically.
n 500.0	Setup of the upper limit of the temperature range. The minimum difference between upper and lower limit is 20 K. The upper limit can only be set to a value = lower limit +20 K.
[ 0.00	Setup of the lower limit of the signal output. This setting allows an assignment of a certain signal output level to the lower limit of the temperature range. The adjustment range corresponds to the selected output mode (e.g. 0 - 5 V).

Display	Description
] 5.00	Setup of the upper limit of the signal output. This setting allows an assignment of a certain signal output level to the lower limit of the temperature range. The adjustment range corresponds to the selected output mode (e.g. 0 - 5 V).
U °C	Setup of the temperature unit [°C or °F]
/ 30.0	Setup of the lower alarm limit. This value corresponds to alarm 1, <a href="#">see 8.5</a> , <a href="#">see 8.5.2</a> and is also used as threshold value for relay 1 (if the optional relay board is used).
// 100.0	Setup of the upper alarm limit. This value corresponds to alarm 2, <a href="#">see 8.5</a> , <a href="#">see 8.5.2</a> and is also used as threshold value for relay 2 (if the optional relay board is used).
XHEAD	<p>Setup of the ambient temperature compensation. In dependence on the emissivity value of the object a certain amount of ambient radiation will be reflected from the object surface. To compensate for this impact, this function allows the setup of a fixed value which represents the ambient radiation.</p> <p><b>i</b> Especially if there is a big difference between the ambient temperature at the object and the sensor temperature the use of ambient temperature compensation is recommended.</p> <p>If XHEAD is shown the ambient temperature value will be taken from the sensor-internal probe. To return to XHEAD, please press  and  together.</p>
M 01	Setup of the Multidrop address. In a RS485 network each sensor will need a specific address. This menu item will only be shown if a RS485 interface board is plugged in. For using the RS422 mode, press once the  button on M 01.
B 9.6	Setup of the baud rate for digital data transfer
S ON	Activating (ON) and Deactivating (OFF) of an optional sighting laser, <a href="#">see A 1.4</a> . By pressing  or  a voltage of 3 VDC will be switched to the 3V SW connection pin on the controller.

## 9.4 Error Messages

The display of the thermoMETER CT can show the following error messages:

### 9.4.1 CT-SF02, CT-SF15, CT-SF22, CTH and CTP Models

OVER	Object temperature too high
UNDER	Object temperature too low
^^^CH	Sensor temperature too high
vvvCH	Sensor temperature too low

### 9.4.2 CTM-1, CTM-2, CTM-3 Models

<b>1. Digit</b>	
0x	No error
1x	Sensor temperature probe short circuit GND
2x	Box temperature too low
4x	Box temperature too high
6x	Box temperature probe disconnected
8x	Box temperature probe short circuit to GND
<b>2. Digit</b>	
x0	No error
x2	Object temperature too high
x4	Sensor temperature too low
x8	Sensor temperature too high
xC	Sensor temperature probe disconnected

## **10. Instructions for Operation**

### **10.1 Cleaning**

Lens cleaning: Blow off loose particles using clean compressed air. The lens surface can be cleaned with a soft, humid tissue moistened with water or a lens cleaner (e.g. Purosol or B+W Lens Cleaner). Never use cleaning compounds which contain solvents (neither for the lens nor for the housing).

> Destruction of the sensor and/or the controller

## 11. CompactConnect Software

➡ Insert the CompactConnect installation CD into the according drive on your computer.

If the auto run option is activated the installation wizard will start automatically.

Otherwise, please start CDsetup.exe from the CD-ROM.

➡ Follow the instructions of the wizard until the installation is finished.

The installation wizard will place a launch icon on the desktop and in the start menu.

If you want to uninstall the CompactConnect software from your system, please use the `uninstall` icon in the start menu.

You will find detailed software manual on the CompactConnect CD.

### 11.1 System Requirements

- Windows 7, 8 and 10
- At least 128 MByte RAM
- USB Interface
- CD-ROM drive
- Hard disc with at least 30 MByte free space

### 11.2 Main Features

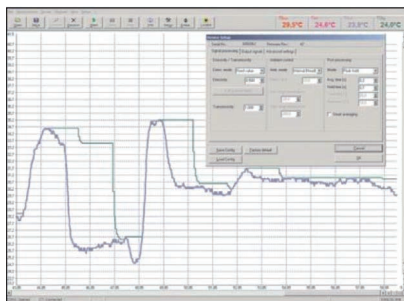


Fig. 30 Graphic display main features

- Graphical display for temperature measuring values and automatic data logging for analysis and documentation
- Complete sensor setup and remote controlling
- Adjustment of signal processing functions
- Programming of outputs and functional inputs

## **12. Communication Settings**

### **12.1 Serial Interface**

Baud rate: 9.6 ... 115.2 kBaud (adjustable on the unit or via CompactConnect software)

Data bits: 8

Parity: none

Stop bits: 1

Flow control: off

### **12.2 Protocol**

All sensors of the CT series are using a binary protocol. They can be switched alternatively to an ASCII protocol. To get a fast communication the protocol has no additional overhead with CR, LR or ACK bytes.

### 12.3 ASCII Protocol

The models CT-SF02, CT-SF15, CT-SF22, CTH-SF02, CTH-SF10 can be switched to ASCII by changing the first figure of block 3 of the sensor calibration code. This figure has to be changed from 0 to 4 (old sensor) respectively 8 to C (new sensor) (always +4; that means on the CTeX this figure has to be changed from 1 to 5), [see 7.5](#).

Old sensor	CTeX (+1)	ASCII (+4)	CTeX + ASCII (+5)
0	1	4	5
New sensor			
8	9	C	D

**Example** Binary: A6FG - 22KB - 8AS0                      ASCII: A6FG - 22KB - CAS0  
**new**                      Block 1   Block 2   Block 3                                      Block 1   Block 2   Block 3  
**sensor**

**i** After you have modified the sensor calibration code a reset is necessary to activate the change, [see 9](#).

To switch to the ASCII protocol you can also use the following command:

Decimal:            131  
 HEX:                0x83  
 Data, answer:    byte 1  
 Result:            0 – Binary protocol  
                       1 – ASCII protocol



## 12.4 Saving of Parameter Settings

After switching on the CT sensor, the flash mode is active. This means that changed parameter settings will be saved in the CT-internal Flash-EEPROM and will also be kept after the sensor is switched off.

In case values should be changed quite often or continuously the flash mode can be switched off by using the following command:

Decimal:	112
HEX:	0x70
Data, answer:	byte 1
Result:	0 – Data will be written into the flash memory 1 – Data will be not written into the flash memory

If the flash mode is deactivated, all settings will only be kept as long as the unit is powered. If the unit is switched off and powered on again, all previous settings are lost.

The command 0x71 will poll the current status.

You will find a detailed protocol and command description on the CompactConnect software CD in the directory: \Commands.

### 13. Basics of Infrared Thermometry

Depending on the temperature each object emits a certain amount of infrared radiation. A change in the temperature of the object is accompanied by a change in the intensity of the radiation. For the measurement of “thermal radiation” infrared thermometry uses a wave-length ranging between  $1 \mu$  and  $20 \mu\text{m}$ . The intensity of the emitted radiation depends on the material. This material contingent constant is described with the help of the emissivity ( $\epsilon$  - Epsilon) which is a known value for most materials, [see A 3](#), [see A 4](#).

Infrared thermometers are optoelectronic sensors. They calculate the surface temperature on the basis of the emitted infrared radiation from an object. The most important feature of infrared thermometers is that they enable the user to measure objects contactless. Consequently, these products help to measure the temperature of inaccessible or moving objects without difficulties. Infrared thermometers basically consist of the following components:

- Lens
- Spectral filter
- Detector
- Controller (Amplifier/linearization/signal processing)

The specifications of the lens decisively determine the optical path of the infrared thermometer, which is characterized by the ratio Distance to Spot size.

The spectral filter selects the wavelength range, which is relevant for the temperature measurement. The emitted infrared radiation is transformed into electrical signals by the detector and the controller.

## 14. Emissivity

### 14.1 Definition

The intensity of infrared radiation, which is emitted by each body, depends on the temperature as well as on the radiation features of the surface material of the measuring object. The emissivity ( $\epsilon$  – Epsilon) is used as a material constant factor to describe the ability of the body to emit infrared energy. It can range between 0 and 100 %. A “blackbody” is the ideal radiation source with an emissivity of 1.0 whereas a mirror shows an emissivity of 0.1.

If the emissivity chosen is too high, the infrared thermometer may display a temperature value which is much lower than the real temperature – assuming the measuring object is warmer than its surroundings. A low emissivity (reflective surfaces) carries the risk of inaccurate measuring results by interfering infrared radiation emitted by background objects (flames, heating systems, chamottes). To minimize measuring errors in such cases, the handling should be performed very carefully and the unit should be protected against reflecting radiation sources.

### 14.2 Determination of Unknown Emissivity

- First of all, determine the current temperature of the measuring object with a thermocouple or contact sensor. The second step is to measure the temperature with the infrared thermometer and modify the emissivity until the displayed measuring value corresponds to the current temperature.
  - If you monitor temperatures of up to 380 °C you may place a special plastic sticker (Part number: TM-ED-CT emissivity dots) onto the measuring object, which covers it completely.
    - ➡ Now set the emissivity to 0.95 and take the temperature of the sticker.
    - ➡ Afterwards, determine the temperature of the adjacent area on the measuring object and adjust the emissivity according to the value of the temperature of the sticker.
  - Cover a part of the surface of the measuring object with a black, flat paint with an emissivity of 0.98.
    - ➡ Adjust the emissivity of your infrared thermometer to 0.98 and take the temperature of the colored surface.
    - ➡ Afterwards, determine the temperature of a directly adjacent area and modify the emissivity until the measured value corresponds to the temperature of the colored surface.
- i** On all three methods the object temperature must be different from the ambient temperature.

### 14.3 Characteristic Emissivity

In the case that none of the methods mentioned above help to determine the emissivity you may use the emissivity tables, [see A 3](#), [see A 4](#). These are only average values. The actual emissivity of a material depends on the following factors:

- Temperature
- Measuring angle
- Geometry of the surface (smooth, convex, concave)
- Thickness of the material
- Constitution of the surface (polished, oxidized, rough, sandblast)
- Spectral range of the measurement
- Transmissivity (e.g. with thin films)

## **15. Liability for Material Defects**

All components of the device have been checked and tested for functionality at the factory. However, if defects occur despite our careful quality control, MICRO-EPSILON or your dealer must be notified immediately. The liability for material defects is 12 months from delivery.

Within this period, defective parts, except for wearing parts, will be repaired or replaced free of charge, if the device is returned to MICRO-EPSILON with shipping costs prepaid. Any damage that is caused by improper handling, the use of force or by repairs or modifications by third parties is not covered by the liability for material defects. Repairs are carried out exclusively by MICRO-EPSILON.

Further claims can not be made. Claims arising from the purchase contract remain unaffected. In particular, MICRO-EPSILON shall not be liable for any consequential, special, indirect or incidental damage. In the interest of further development, MICRO-EPSILON reserves the right to make design changes without notification.

For translations into other languages, the German version shall prevail.

## 16. Service, Repair

If the sensor, controller or the sensor cable is defective, please send us the affected parts for repair or exchange.

If the cause of a fault cannot be clearly identified, please send the entire measuring system to:

For customers in USA applies:

Send the affected parts or the entire measuring system back to:

For customers in Canada or South America applies:

Please contact your local distributor.

## 17. Decommissioning, Disposal

➡ Remove the cables from sensor and controller.

Incorrect disposal may cause harm to the environment.

➡ Dispose of the device, its components and accessories, as well as the packaging materials in compliance with the applicable country-specific waste treatment and disposal regulations of the region of use.

MICRO-EPSILON MESSTECHNIK  
GmbH & Co. KG  
Koenigbacher Str. 15  
94496 Ortenburg / Germany  
Tel. +49 (0) 8542/ 168-0  
Fax +49 (0) 8542 / 168-90  
info@micro-epsilon.com  
www.micro-epsilon.com

MICRO-EPSILON USA  
8120 Brownleigh Dr.  
Raleigh, NC 27617 /USA  
Tel. +1 919 / 787-9707  
Fax +1 919 / 787-9706  
me-usa@micro-epsilon.com  
www.micro-epsilon.com

## Appendix

### A 1 Accessories

#### A 1.1 Mounting Accessories

The mounting bracket [TM-FB-CT] is adjustable in one axis.

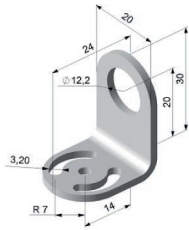


Fig. 31 Mounting bracket [TM-FB-CT]

The mounting fork [TM-MG-CT], adjustable in two axes, can be combined with the mounting bracket [TM-FB-CT] using the M12x1 thread.

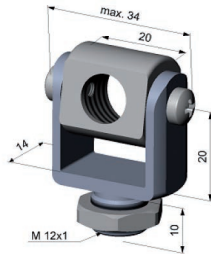


Fig. 33 Mounting fork [TM-MG-CT]

The mounting bold [TM-MB-CT] with M12x1 thread is adjustable in one axis.

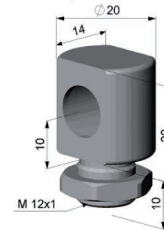


Fig. 32 Mounting bold [TM-MB-CT]

The mounting bracket, adjustable in two axes [TM-AB-CT] consisting of TM-FB-CT and TM-MB-CT.

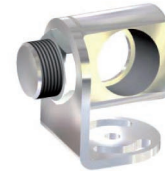
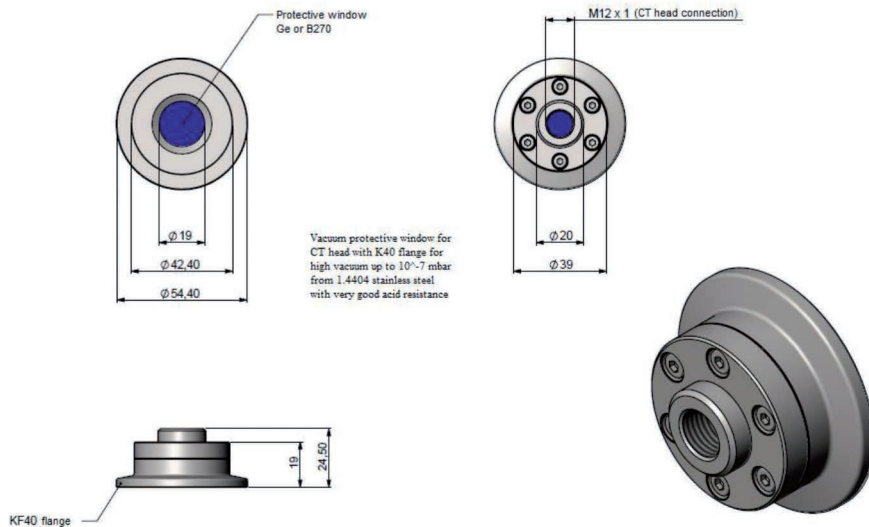


Fig. 34 Mounting bracket [TM-AB-CT]



KF40 flange (TM-KF40GE-CT) with Ge window or TM-KF40B270-CT for CTM-1, CTM2, CTM3 with B270 window

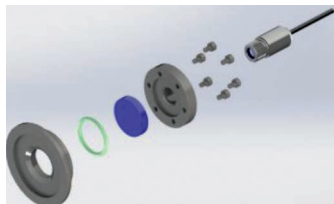


Fig. 35 KF40 flange (TM-KF40GE-CT); explosion graphics

➡ When changing the screws during assembly, tighten the screws to 1 Nm tightening torque.



**NOTICE****A 1.2 Air Purge Collars**

Avoid disposals (dust, particles) on the lens as well as smoke, haze and high humidity (condensation).  
> Error measurements

These effects can be reduced by using an air purge collar.

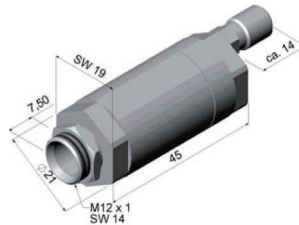
**i** Make sure to use oil-free technically clean air, only.

**A 1.2.1 Standard Air Purge Collar**

Standard air purge collar [TM-AP-CT] for CT-SF22, CT-SF15 and CTF-SF10 for optics with D:S  $\geq$  10:1 fits to the mounting bracket TM-FB-CT.

Hose connection: 3 x 5 mm

Thread (fitting): M5

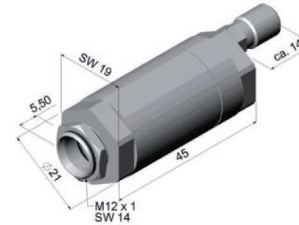


*Fig. 36 Standard air purge collar [TM-AP-CT]*

Standard air purge collar [TM-AP2-CT] for CT-SF02 for optics with D:S  $\leq$  2:1 fits to the mounting bracket TM-FB-CT.

Hose connection: 3 x 5 mm

Thread (fitting): M5



*Fig. 37 Standard air purge collar [TM-AP2-CT]*

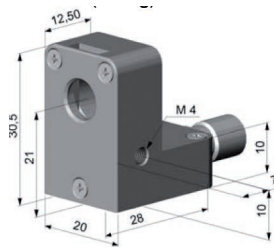
The needed amount of air (approximately 2 ... 10 l/min.) depends on the application and the installation conditions on-site.

### A 1.2.2 Laminar Air Purge Collar

The sideward air outlet TM-APL-CT prevents a cooling down of the object in short distances.

Hose connection: 3 x 5 mm

Thread (fitting): M5



*Fig. 38 Laminar air purge collar [TM-AP-CT]*

The needed amount of air (approximately 2 ... 10 l/min.) depends on the application and the installation conditions on-site.

A combination of the laminar air purge collar with the bottom section of the mounting fork TM-MG-CT allows an adjustment in two axes.



*Fig. 39 Laminar air purge collar and mounting fork [TM-APL-CT + TM-MG-CT]*

### A 1.3 CF Lens and Protective Window

The optional CF lens allows the measurement of very small objects and can be used in combination with the CT-SF02, CT-SF15, CT-SF22, CTM-1, CTM-2, CTM-3 models. The minimum spot size depends on the used sensor. The distance is always measured from the front edge of the CF lens holder or laminar air purge collar. The installation on the sensor will be done by turning the CF lens [TM-CF-CT] until end stop. To combine it with the massive housing please use the version with external thread M12x1 [TM-CFAG-CT].

**i** If the CF lens is used, the transmission <sup>1</sup> at CT systems has to be set as follows (averaging values):

CT-SF02/CTSF15/CT-SF22:	0.78
CTM-1	0.80
CTM-2:	0.87
CTM-3:	0.92

Model overview:

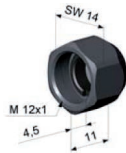
TM-CF-CT	CF lens for installation on sensor [CT-SF02/CT-SF15/CT-SF22]
TM-CFH-CT	CF lens for installation on sensor [CTM-1/CTM-2/CTM-3]
TM-CFAG-CT	CF lens with external thread for installation in massive housing [CT-SF02/CT-SF15/ CT-SF22]
TM-CFHAG-CT	CF lens with external thread for installation in massive housing [CTM-1/CTM-2/CTM-3]

For protection of the sensor optics a protective window is available. The mechanical dimensions are equal to the CF lens. It is available in the following versions:

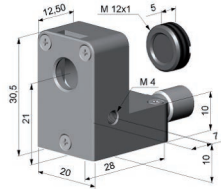
TM-PW-CT	Protective window for mounting on sensor [CT-SF02/CT-SF15/CT-SF22]
TM-PWAG-CT	Protective window for mounting on sensor [CTM-1/CTM-2/CTM-3]
TM-PWAG-CT	Protective window with external thread for installation in massive housing [CT-SF02/ CT-SF15/CT-SF22]
TM-PWHAG-CT	Protective window with external thread for installation in massive housing [CTM-1/ CTM-2/CTM-3]

1) Deviations possible

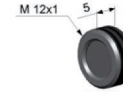
**i** If the protective window is used, the transmission <sup>1</sup> has to be set as follows (average values):  
 0.83 [CT-SF02/CT-SF15/CT-SF22] or 0.93 [CTM-1, CTM-2, CTM-3].



*Fig. 40 CF lens [TM-CF-CT]  
 respectively protective window  
 [TM-PW-CT]*



*Fig. 41 Laminar air purge with  
 integrated CF lens  
 [TM-APLCF-CT]*



*Fig. 42 CF lens [TM-CFAG-CT]  
 respectively protective window  
 with external thread [TM-PWAG-  
 CT]*

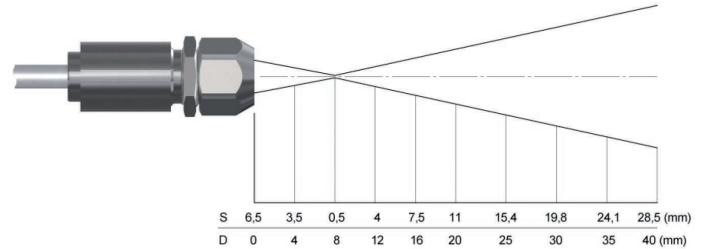
1) Deviations possible

**CTF-SF25 + CF lens**

0.5 mm @ 8 mm

0.5 mm @ 6 mm [TM-APLCF-CT]

D:S (far field) = 1.6:1

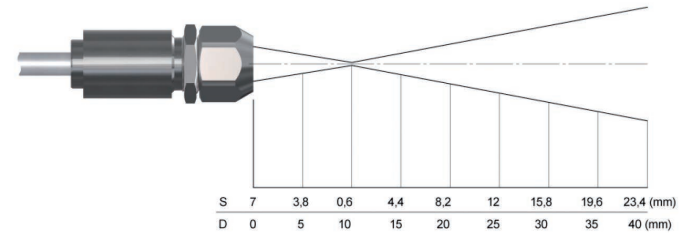


**CT-SF22 + CF lens**

0.6 mm @ 10 mm

0.6 mm @ 8 mm [TM-APLCF-CT]

D:S (far field CF) = 1.5:1

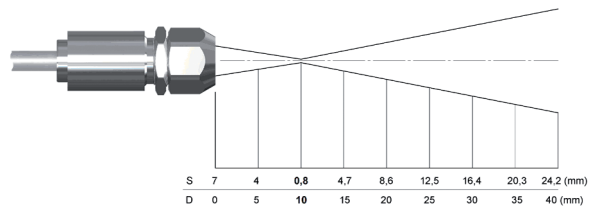


**CT-SF15/ CTF-SF15 + CF lens**

0.8 mm @ 10 mm

0.8 mm @ 8 mm [TM-APLCF-CT]

D:S (far field) = 1.2:1

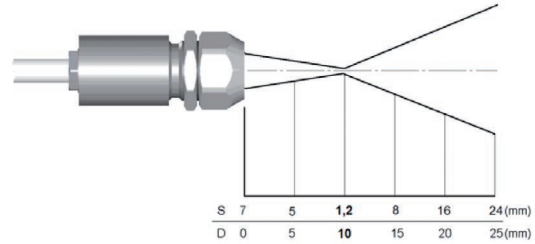


**CTH-SF10 + CF lens**

1.2 mm @ 10 mm

1.2 mm @ 8 mm [TM-APLCF-CT]

D:S (far field) = 1.2:1

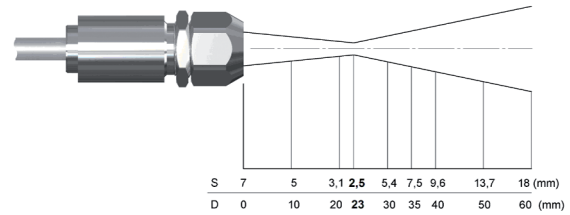


**CT-SF02 / CTH-SF02 + CF lens**

2.5 mm @ 23 mm

2.5 mm @ 21 mm [TM-APLCF-CT]

D:S (far field) = 5:1



## A 1.4 Further Accessories

### A 1.4.1 Right Angle Mirror

The right angle mirror [TM-RAM-CT] for optics with D:S  $\geq$  10:1 enables measurements with 90 ° angle to sensor axis.

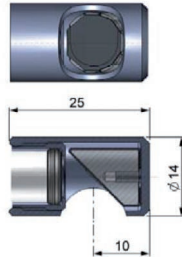


Fig. 43 Right angle mirror [TM-RAM-CT]

The mirror has a reflection of 96 % in combination with a CT-SF22 and CT-SF15 and 88 % with a CTF-SF15. If the mirror is used this value has to be multiplied by the emissivity value of the measurement object.

**Example:** CT-SF22 and object with emissivity = 0.85

$$0.85 \times 0.96 = 0.816$$

Thus the emissivity in the CT-SF22 has to be set to the resulting value of 0.816.

#### A 1.4.2 Rail Mount Adapter for Controller

With rail mount adapter the CT controller can be mounted easily on a DIN rail (TS35) according to EN50022.

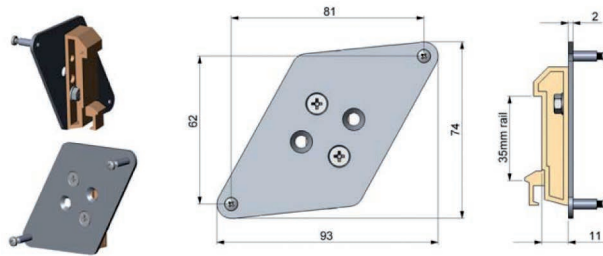


Fig. 44 Rail mount adapter for controller [TM-RAIL-CT]

#### A 1.4.3 Tilt Assembly for CT Sensors

With this mounting accessory a fine adjustment of the CT sensor with an off-axis angle  $\pm 6,5^\circ$  is possible.

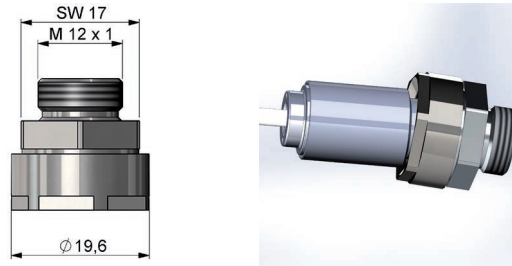


Fig. 45 Tilt assembly [TM-TAS-CT]



**VORSICHT**

Laser radiation.  
Irritation or injury of the eyes possible. Close your eyes or immediately turn away if the laser beam hits the eye.  
Do not stare into the laser beam. Avoid indirect exposure via reflective surfaces!

**A 1.4.4 Laser Sighting Tool**

The laser sighting tool [TM-LST-CT], battery powered (2x Alkaline AA), for alignment of CT sensors. The laser head has similar mechanical dimensions as the CT sensor.



*Fig. 46 Laser sighting tool [TM-LST-CT]*



*Fig. 47 Laser label*

During operation of the sensor, the pertinent regulations according to IEC 60825-1 on “Safety of laser products” must be fully observed at all times, [see 2](#). The sensor complies with the applicable laws for the manufacturer of laser devices.

### A 1.4.5 OEM Laser Sighting Tool

The OEM laser sighting tool is available with 3.5 m [TM-LSTOEM-CT] and 8 m connection cable [TM-LSTOEM-CT (008)]. The laser can be connected to the pins 3V SW and GND, see Chap. 6. and switched on and off via the programming keys or via the CompactConnect software.

The special double-hole mounting bracket [TM-FB2-CT] allows a simultaneous mounting of the CT sensor and the laser head.

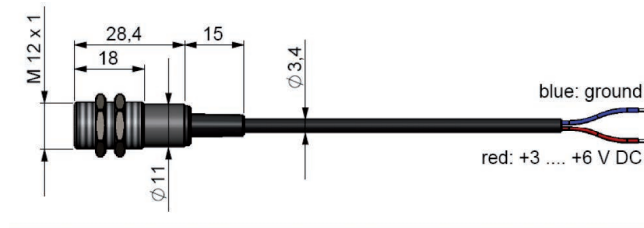


Fig. 48 OEM laser sighting tool [TM-LSTOEM-CT]

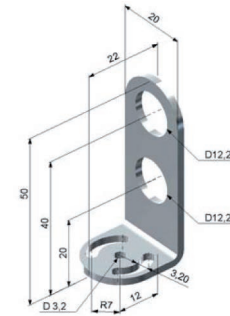


Fig. 49 Double-hole mounting bracket [TM-FB2-CT]

### A 1.4.6 Massive Housing

The massive housing [TM-MHS-CT] is available in aluminum (anodized) or brass.



Fig. 50 Massive housing, stainless steel [TM-MHS-CT]

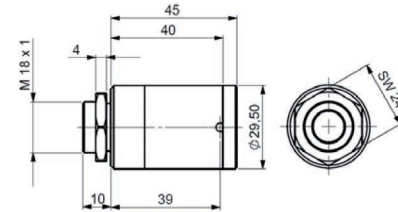


Fig. 51 Dimensional drawing massive housing, stainless steel

Dimensions in mm (inches), not to scale

The massive housing allows reproducible and stable measurements on applications with significant and short-term variation in ambient temperatures. It can be combined with the CF lens [TM-CFAG-CT] or with the protective window [TM-PWAG-CT, [see 6](#)].

**i** For an optimum function of the massive housing 10 cm of the sensor cable must be installed in loops inside the housing.

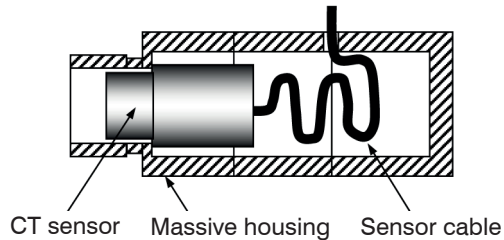
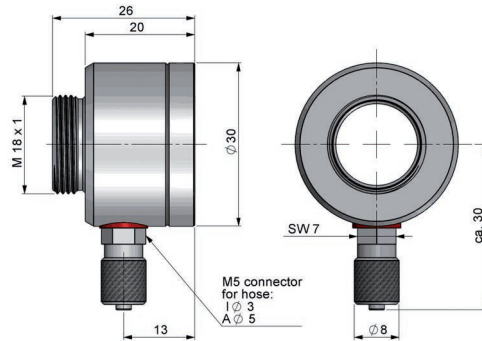


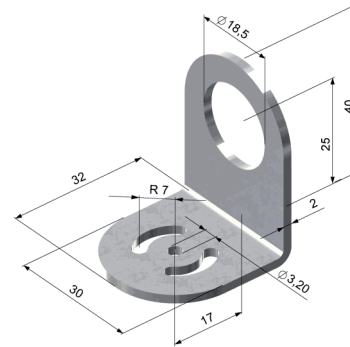
Fig. 52 Massive housing

### A 1.4.7 Accessories for Massive Housing



*Fig. 53 Air purge collar for massive housing (thread M18x1) [TM-APMH-CT]*

The needed amount of air (approx. 2 ... 10 l/ min.) depends on the application and the installation conditions on-site.

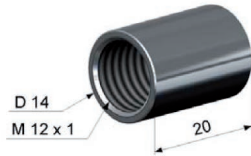


*Fig. 54 Mounting bracket for massive housing, adjustable in one axis [TM-FBMH-CT]*

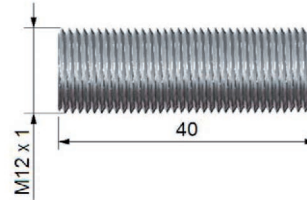
**A 1.4.8****A 1.4.9 Pipe Adapter and Sighting Tubes**

The pipe adapter [TM-PA-CT] allows an assembling of sighting tubes directly on the CT sensor. The sighting tubes are available in 3 different lengths:

TM-ST20-CT	Length: 20 mm
TM-ST40-CT	Length: 40 mm
TM-ST88-CT	Length: 88 mm



*Fig. 55 Pipe adapter TM-PA-CT*



*Fig. 56 Sighting tube TM-ST40-CT*

The sighting tubes can only be used for sensors with a distance-to-spot ratio (D:S) of  $\geq 15:1$ .

## A 2 Factory Settings

The devices have following presettings at time of delivery:

Signal output object temperature	0 - 5 V
Emissivity	0.970 (CTP-3, CTP-7)/1.000 (CTM-1, CTM-2, CTM-3)
Transmissivity	1.000
Averaging (AVG)	0.2 s (CTF: 0.1 s)/(CTM-1, CTM-2, CTM-3: 0.001 s)
Smart Averaging	inactive/(CTF, CTM-1, CTM-2, CTM-3: active)
Peak hold (MAX)	inactive
Valley hold (MIN)	inactive
Lower limit signal output	0 V
Upper limit signal output	5 V
Temperature unit	°C
Ambient temperature compensation <sup>1</sup>	internal sensor temperature probe
Baud rate [kBaud]	115

1) Output at OUT-AMB as 0 - 5 V signal on CT-SF and CTP-7

Model	CT-SF02/15/22/ CTF/CTH	CTM-1SF40	CTM- 1SF75	CTM-1SF75H1	CTM- 2SF40	CTM- 2SF75
Lower limit temperature range [°C]	0	485	650	800	250	385
Upper limit temperature range [°C]	500	1050	1800	2200	800	1600
Lower alarm limit [°C] (normally closed)	30	600	800	1200	350	500
Upper alarm limit [°C] (normally open)	100	900	1400	1600	600	1200

Model	CTM-2SF75H1	CTM-3SF22	CTM-3SF33	CTM-3SF75H1
Lower limit temperature range [°C]	490	50	100	150
Upper limit temperature range [°C]	2000	400	600	1000
Lower alarm limit [°C] (normally closed)	800	100	250	350
Upper alarm limit [°C] (normally open)	1400	300	500	600

Model	CTM-3SF75H2	CTM-3SF75H3	CTP-7	CTP-3
Lower limit temperature range [°C]	200	250	0	50
Upper limit temperature range [°C]	1500	1800	710	400
Lower alarm limit [°C] (normally closed)	550	750	30	200
Upper alarm limit [°C] (normally open)	1000	1200	100	300

Smart Averaging means a dynamic average adaptation at high signal edges (activation via CompactConnect software only), [see A 5](#).

**A 3 Emissivity Table Metals**

**i** Please note that these are only approximate values, which were taken from various sources.

Material		Typical Emissivity			
		1.0 $\mu\text{m}$	1.6 $\mu\text{m}$	5.1 $\mu\text{m}$	8 - 14 $\mu\text{m}$
Spectral response		1.0 $\mu\text{m}$	1.6 $\mu\text{m}$	5.1 $\mu\text{m}$	8 - 14 $\mu\text{m}$
Aluminum	Non oxidized	0.1 - 0.2	0.02 - 0.2	0.02 - 0.2	0.02 - 0.1
	Polished	0.1 - 0.2	0.02 - 0.1	0.02 - 0.1	0.02 - 0.1
	Roughened	0.2 - 0.8	0.2 - 0.6	0.1 - 0.4	0.1 - 0.3
	Oxidized	0.4	0.4	0.2 - 0.4	0.2 - 0.4
Brass	Polished	0.35	0.01 - 0.05	0.01 - 0.05	0.01 - 0.05
	Roughened	0.65	0.4	0.3	0.3
	Oxidized	0.6	0.6	0.5	0.5
Copper	Polished	0.05	0.03	0.03	0.03
	Roughened	0.05 - 0.2	0.05 - 0.2	0.05 - 0.15	0.05 - 0.1
	Oxidized	0.2 - 0.8	0.2 - 0.9	0.5 - 0.8	0.4 - 0.8
Chrome		0.4	0.4	0.03 - 0.3	0.02 - 0.2
Gold		0.3	0.01 - 0.1	0.01 - 0.1	0.01 - 0.1
Haynes	Alloy	0.5 - 0.9	0.6 - 0.9	0.3 - 0.8	0.3 - 0.8
Inconel	Electro polished	0.2 - 0.5	0.25	0.15	0.15
	Sandblast	0.3 - 0.4	0.3 - 0.6	0.3 - 0.6	0.3 - 0.6
	Oxidized	0.4 - 0.9	0.6 - 0.9	0.6 - 0.9	0.7 - 0.95



Material		Typical Emissivity			
		1.0 $\mu\text{m}$	1.6 $\mu\text{m}$	5.1 $\mu\text{m}$	8 - 14 $\mu\text{m}$
Spectral response		1.0 $\mu\text{m}$	1.6 $\mu\text{m}$	5.1 $\mu\text{m}$	8 - 14 $\mu\text{m}$
Iron	Non oxidized	0.35	0.1 - 0.3	0.05 - 0.25	0.05 - 0.2
	Rusted		0.6 - 0.9	0.5 - 0.8	0.5 - 0.7
	Oxidized	0.7 - 0.9	0.5 - 0.9	0.6 - 0.9	0.5 - 0.9
	Forget, blunt	0.9	0.9	0.9	0.9
	Molten	0.35	0.4 - 0.6		
Iron, casted	Non oxidized	0.35	0.3	0.25	0.2
	Oxidized	0.9	0.7 - 0.9	0.65 - 0.95	0.6 - 0.95
Lead	Polished	0.35	0.05 - 0.2	0.05 - 0.2	0.05 - 0.1
	Roughened	0.65	0.6	0.4	0.4
	Oxidized		0.3 - 0.7	0.2 - 0.7	0.2 - 0.6
Magnesium		0.3 - 0.8	0.05 - 0.3	0.03 - 0.15	0.02 - 0.1
Mercury			0.05 - 0.15	0.05 - 0.15	0.05 - 0.15
Molybdenum	Non oxidized	0.25 - 0.35	0.1 - 0.3	0.1 - 0.15	0.1
	Oxidized	0.5 - 0.9	0.4 - 0.9	0.3 - 0.7	0.2 - 0.6
Monel (Ni-CU)		0.3	0.2 - 0.6	0.1 - 0.5	0.1 - 0.14
Nickel	Electrolytic	0.2 - 0.4	0.1 - 0.3	0.1 - 0.15	0.05 - 0.15
	Oxidized	0.8 - 0.9	0.4 - 0.7	0.3 - 0.6	0.2 - 0.5
Platinum	Black		0.95	0.9	0.9
Silver		0.04	0.02	0.02	0.02

<b>Material</b>		<b>Typical Emissivity</b>			
Spectral response		1.0 $\mu\text{m}$	1.6 $\mu\text{m}$	5.1 $\mu\text{m}$	8 - 14 $\mu\text{m}$
Steel	Polished plate	0.35	0.25	0.1	0.1
	Rustless	0.35	0.2 - 0.9	0.15 - 0.8	0.1 - 0.8
	Heavy plate			0.5 - 0.7	0.4 - 0.6
	Cold-rolled	0.8 - 0.9	0.8 - 0.9	0.8 - 0.9	0.7 - 0.9
	Oxidized	0.8 - 0.9	0.9 - 0.9	0.7 - 0.9	0.7 - 0.9
Tin	Non oxidized	0.25	0.1 - 0.3	0.05	0.05
Titanium	Polished	0.5 - 0.75	0.3 - 0.5	0.1 - 0.3	0.05 - 0.2
	Oxidized		0.6 - 0.8	0.5 - 0.7	0.5 - 0.6
Wolfram	Polished	0.35 - 0.4	0.1 - 0.3	0.05 - 0.25	0.03 - 0.1
Zinc	Polished	0.5	0.05	0.03	0.02
	Oxidized	0.6	0.15	0.1	0.1

**A 4 Emissivity Table Non Metals**

**i** Please note that these are only approximate values which were taken from various sources.

Material	Typical Emissivity			
	1.0 $\mu\text{m}$	2.2 $\mu\text{m}$	5.1 $\mu\text{m}$	8 - 14 $\mu\text{m}$
Spectral response				
Asbest	0.9	0.8	0.9	0.95
Aphalt			0.95	0.95
Basalt			0.7	0.7
Carbon	Non oxidized	0.8 - 0.9	0.8 - 0.9	0.8 - 0.9
	Graphite	0.8 - 0.9	0.7 - 0.9	0.7 - 0.9
Carborundum	0.4	0.8 - 0.95	0.8 - 0.95	0.95
Cement	0.65	0.9	0.9	0.95
Glass	Plate	0.2	0.98	0.85
	Melt	0.4 - 0.9	0.9	
Grit			0.95	0.95
Gypsum			0.4 - 0.97	0.8 - 0.95
Ice				0.98
Limestone			0.4 - 0.98	0.98
Paint	Non alkaline			0.9 - 0.95
Paper	Any color		0.95	0.95
Plastic > 50 $\mu\text{m}$	Non transparent		0.95	0.95
Rubber			0.9	0.95
Sand			0.9	0.95

<b>Material</b>	<b>Typical Emissivity</b>			
	<b>1.0 <math>\mu\text{m}</math></b>	<b>2.2 <math>\mu\text{m}</math></b>	<b>5.1 <math>\mu\text{m}</math></b>	<b>8 - 14 <math>\mu\text{m}</math></b>
Spectral response				
Snow				0.9
Soil				0.9 - 0.98
Textiles			0.95	0.95
Water				0.93
Wood	Natural		0.9 - 0.95	0.9 - 0.95

## A 5 Smart Averaging

The average function is generally used to smoothen the signal curves. With the adjustable parameter time this function can be optimal adjusted to the respective application. One disadvantage of the average function is that fast temperature peaks which are caused by dynamic events are subjected to the same averaging time. Therefore those peaks can only be seen with a delay on the signal output.

The function Smart Averaging eliminates this disadvantage by passing those fast events without averaging directly through to the signal output.

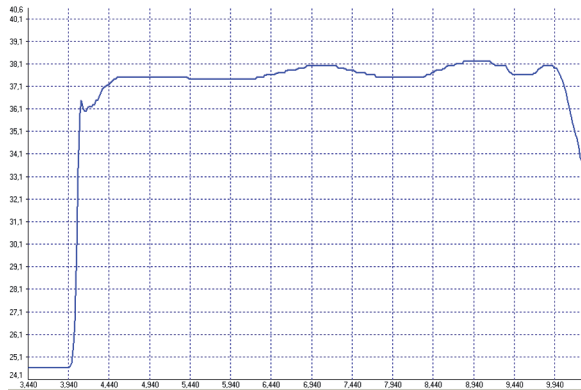


Fig. 57 Signal curve with Smart Averaging function

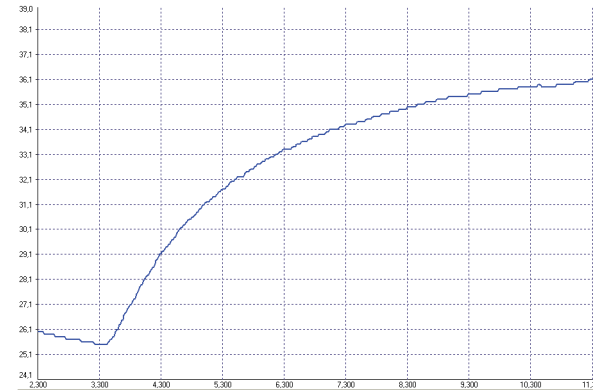


Fig. 58 Signal curve without Smart Averaging function



MICRO-EPSILON MESSTECHNIK GmbH & Co. KG  
Koenigbacher Str. 15 · 94496 Ortenburg / Germany  
Tel. +49 (0) 8542 / 168-0 · Fax +49 (0) 8542 / 168-90  
info@micro-epsilon.com · www.micro-epsilon.com  
Your local contact: [www.micro-epsilon.com/contact/worldwide/](http://www.micro-epsilon.com/contact/worldwide/)

X9751190-B082050HDR

© MICRO-EPSILON MESSTECHNIK

