



# More Precision

**thermoMETER** // Non-contact infrared temperature sensors





### thermoMETER CTLaserCOMBUSTION

Non-contact IR temperature sensor with laser sighting for measurements through flames and of flame gases in combustion processes from 200 °C to 1450 °C (optional up to 1650 °C).

The CTLC-4 is ideally suitable to monitor workpieces inside ovens, to measure inside chemical reactors and to inspect the brick temperature in combustion chambers.

- Measuring range 200 °C to 1450 °C
- Double laser marks exact spot size from 1.6 mm
- Usable in all modern applications where "size of spot matters"
- Optical system 45:1 with selectable focus
- Up to 85 °C ambient temperature without cooling
- Automatic laser switch-off at 50 °C
- Cooling and protection accessories for harsh environmental conditions

#### Optical specifications thermoMETER CTLasercombustion

□ = smallest spot size / focal point (mm)

##### Standard Focus

SF45 lens	45:1	20	20.8	21.7	22.5	23.4	24.2	25	25.9	26.7	32.5	38.4	50.1	61.7	73.4		
distance in mm		0	150	300	450	600	750	900	1050	1200	1350	1500	1800	2100	2400		

##### Close Focus

CF1 lens	45:1	20	9.5	6.9	1.6	10.9	26.3	41.7	57.1	72.6	88	103.4	118.9	134.3	165.1	196	226.9
CF2 lens	45:1	20	15.6	14.5	12.3	8.9	3.4	11.2	19	26.8	34.6	42.4	50.2	58	73.6	89.2	104.8
CF3 lens	45:1	20	16.9	16.1	14.6	12.3	8.4	4.5	10.6	16.8	22.9	29	35.1	41.3	53.5	65.8	78
CF4 lens	45:1	20	19.1	18.9	18.4	17.8	16.7	15.6	14.4	13.3	12.2	11.1	10	13.3	20	26.7	33.3
distance in mm		0	40	50	70	100	150	200	250	300	350	400	450	500	600	700	800

Model	CTLC-4SF45-C3	CTLC-2SF45-C3	CTLC-6SF45-C3
Optical resolution	45:1	45:1	45:1
Temperature range <sup>1)</sup>	200 °C to 1450 °C (optional 400 °C to 1650 °C)		
Spectral range	3.9 μm	4.24 μm	4.64 μm
Fields of application	through flames to monitor workpieces inside ovens, to measure inside chemical reactors, to observe the brick temperature in combustion chambers	CO <sub>2</sub> flame gases in combustion processes, garbage burning or processes inside chemical reactors	CO flame gases in combustion processes, garbage burning or processes inside chemical reactors
System accuracy <sup>3), 4)</sup>	± 1 %		
Repeatability <sup>3)</sup>	± 0.5 % or ± 0.5 °C		
Temperature resolution (digital)	0.1 °C		
Response time (90% signal) <sup>2)</sup>	10 ms		
Emissivity/gain <sup>1)</sup>	0.100 to 1.100		
Transmissivity/gain <sup>1)</sup>	0.100 to 1.000		
Signal processing <sup>1)</sup>	peak hold, valley hold, average; extended hold function with threshold and hysteresis		
Outputs/analog	channel 1	0/4 to 20 mA, 0 to 5/10 V; thermocouple J, K	
	channel 2	sensor temperature (-20 °C to 180 °C as 0 to 5 V/10 V), alarm output	
Alarm output	open collector (24 V / 50 A)		
Optional	relays: 2 x 60 VDC/42 VAC <sub>eff</sub> ; 0.4 A; electrically isolated		
Outputs/digital	optional	USB, RS232, RS485, CAN, Profibus DP, Ethernet	
Output impedances	current output	mA max. 500 Ω (with 8 to 36 VDC)	
	voltage output	mV min. 100 kΩ load impedance, thermocouple 20 Ω	
Inputs	programmable functional inputs for external emissivity adjustment, ambient temperature compensation, trigger		
Cable length	3 m (standard), 8 m, 15 m		
Power supply	8 to 36 VDC; max. 160 mA		
Laser	class II (635 nm), 1 mW, ON/OFF via controller or software		
Protection class	IP65 (NEMA-4)		
Ambient temperature	sensor: -20 °C to 85 °C (50 °C if Laser ON); controller: 0 °C to 85 °C		
Storage temperature	-40 °C to 85 °C		
Relative humidity	10 to 95 %, non-condensing		
Vibration	IEC 68-2-6: 3 G, 11 to 200 Hz, any axis		
Shock	IEC 68-2-27: 50 G, 11 ms, any axis		
Weight	sensor: 600 g; controller: 420 g		

<sup>1)</sup> adjustable via programming keys or software

<sup>2)</sup> with dynamic adaption at low signal levels

<sup>3)</sup> ambient temperature 23 ± 5 °C; whichever is greater; object temperature ≥ 0 °C

<sup>4)</sup> ε = 1, response time 1 s

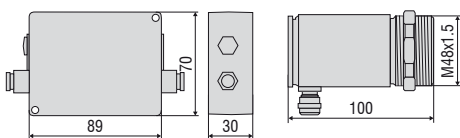

### Product identification

CTLC -	4	SF45-	C3
Cable length [3 m (standard) / 8 m / 15 m]			
Focus [SF45 / CF1 / CF2 / CF3 / CF4]			
Spectral range [4 = 3.9 μm / 2 = 4.24 μm / 6 = 4.64 μm]			
thermoMETER CTLaserCOMBUSTION			

### Accessories page 20 - 21

- Mounting bracket
- Air purge collar
- Rail mount adapter for controller
- Water cooled housing
- Interface kit
- Certificate of calibration



**CTLaser / CTLaserFAST / CTLaserGLASS / CTLaserM1/M2/M3/M5 / CTLaserCOMBUSTION**

**Controller**

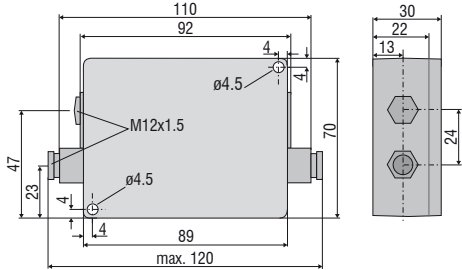

**Sensor**

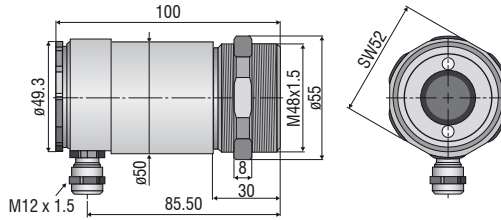

**CTRatioM1/M2**

**Controller**

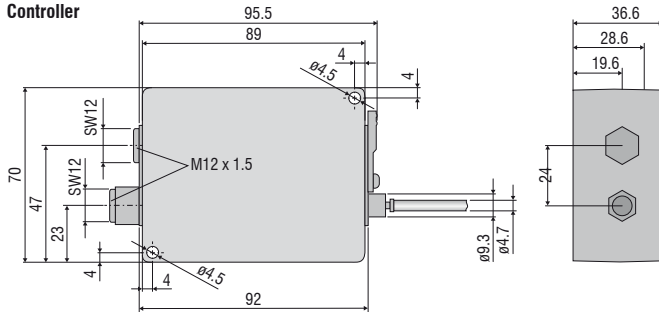

**Sensor**

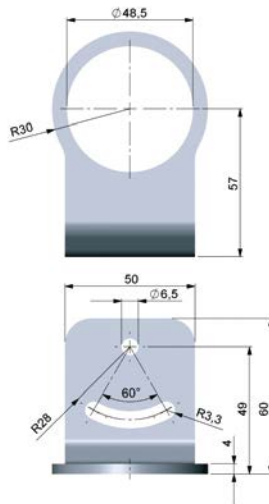
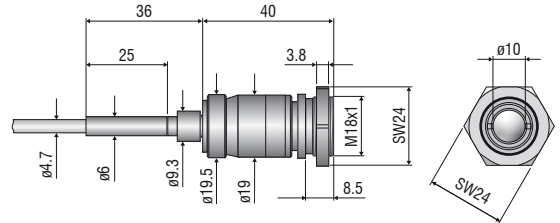

TM-FB-CTL Mounting bracket (fixed); included in CTL scope of supply

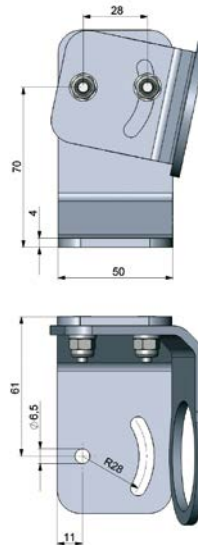

TM-AB-CTL Mounting bracket (adjustable)



TM-W-CTL Water cooled housing and air purge collar TM-AP-CTL, mounted on adjustable mounting bracket TM-AB-CTL

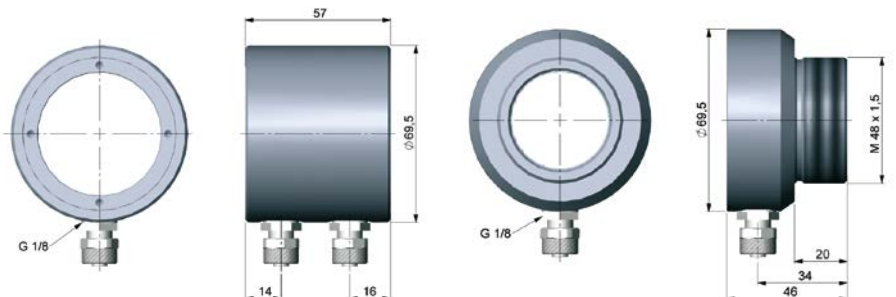

TM-W-CTL Water cooled housing

TM-AP-CTL Air purge collar

Mechanical accessories		
Art. No.	Model	
2970238	TM-AB-CTL	Mounting bracket, adjustable, stainless steel
2970239	TM-AP-CTL	Air purge collar, stainless steel
2970240	TM-W-CTL	Water cooled housing, stainless steel, for ambient temperatures up to 175 °C
2970241	TM-RAIL-CTL	Rail mount adapter for CTLaser controller
2970242	TM-COV-CTL	Closed cover for controller
2970243	TM-MN-CTL	Mounting nut, stainless steel (spare)
2970244	TM-FB-CTL	Mounting bracket, fixed, stainless steel (spare)
2970298	TM-A20UN-CTL	Screw adapter M48x1.5 on 20UN-2A screw including mounting nut

High temperature accessories		
2970366	TM-J-CTL	Cooling jacket (length 228 mm, ø89 mm) (conversion kit TM-CONK-CTL is required)
2970374	TM-CONK-CTL	Conversion kit for CTL on axial cable exit, for integration in cooling jacket
2970368	TM-JAB-CTL	Adjustable mounting bracket for cooling jacket
2970369	TM-MF-CTL	Mounting flange M48x1.5 for TM-PF-CTL
2970370	TM-AST300-CTL	Reflection protection tube M48x1.5, 300 mm length
2970371	TM-PA-CTL	Pipe adapter M48x1.5
2970372	TM-RM-CTL	Furnace wall mount accessory for CTL (TM-MF-CTL, TM-AST300-CTL and TM-PA-CTL)
2970412	TM-PF-CTL	Pipe flange M48x1.5 for directly mounting a CTL sensor
2970487	TM-CJA-CTL	Cooling Jacket Advanced - universal cooling jacket for CSLaser, CTLaser and CTVideo / CSVideo up to 315 °C

Calibration		
2970253	TM-CERT-CTL	Certificate of calibration
2970324	TM-HTCERT-CTL	Certificate of calibration for CTLaser M1-/M2-/M3-/M5-/G-sensors

Interfaces		
2970245	TM-USBK-CTL	USB interface, computer cable, CompactConnect software second cable gland for controller
2970246	TM-RS232K-CTL	RS232 interface, computer cable, CompactConnect software, second cable gland for controller
2970338	TM-RS485USBK-CTL	RS485-USB-adapter, incl. PC cable, CompactConnect software and CTmulti, second cable gland for use with interface board TM-RS485B-CTL
2970248	TM-RS485B-CTL	RS485 interface board incl. second cable gland
2970249	TM-CANK-CTL	CAN-Bus interface; protocol: CANopen Presets: module address20 (14H), 250 kBaud, 0-60 °C
2970250	TM-PFBDPK-CTL	Profibus-DPV1 interface with plug-in connection
2970251	TM-ETHNK-CTL	Ethernet-Kit: interface board, external Ethernet adapter, CompactConnect software, second cable gland
2970252	TM-RI-CTL	Relay interface: two electrically isolated relays, 60 VDC/ 42 VAC <sub>eff</sub> 0.4 A

Sensor cables and high temperature cables for CTLaser		
2970374	TM-CONK-CTL	Connector-Kit for cables with connector
4800254.003	TM-CB3C-CTL	Sensor cable with connector (3 m)
4800254.003H	TM-CB3HC-CTL	High-temperature sensor cable (up to 180 °C) with connector (3 m)
4800254.008	TM-CB8C-CTL	Sensor cable with connector (8 m)
4800254.008H	TM-CB8HC-CTL	High-temperature sensor cable (up to 180 °C) with connector (8 m)
4800254.015	TM-CB15C-CTL	Sensor cable with connector (15 m)
4800254.015H	TM-CB15HC-CTL	High-temperature sensor cable (up to 180 °C) with connector (15 m)



TM-J-CTL Cooling jacket (length 228 mm, ø 89 mm) with adjustable mounting bracket TM-JAB-CTL; suitable for ambient temperatures up to 180°C

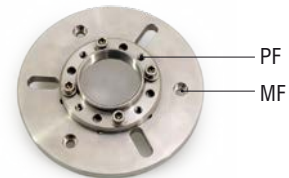

TM-PF-CTL and TM-MF-CTL mounting flange M48x1.5 for directly mounting a CTL sensor

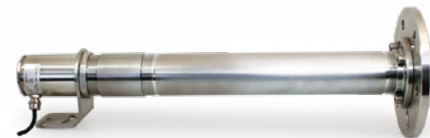

TM-RM-CTL Furnace wall mount accessory for CTLaser / CTRatio: TM-MF-CTL, TM-PF-CTL, TM-AST300-CTL and TM-PA-CTL

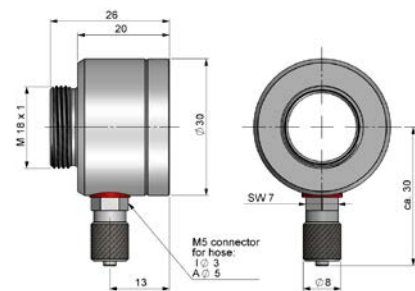

TM-AP-CTR Air purge collar

CTRatio		
Art. No.	Model	
2970348	TM-FB-CTR	Mounting bracket, stainless steel, adjustable in one axis
2970395	TM-AP-CTR	Air purge collar, stainless steel
2970373	TM-RM-CTR	Furnace wall mount
2970351	TM-CERT-CTR	Certificate of calibration

## Further IR temperature measurement devices from Micro-Epsilon



**thermoIMAGER TIM**  
Compact USB thermal imaging cameras  
for precise thermography



**thermoMETER CTVideo/CSVideo**  
Infrared temperature sensors with crosshair  
laser sighting and video output



**thermoMETER Handheld**  
Innovative handheld pyrometer with laser  
sighting for inspection and maintenance