

Fig. 3 Start of measuring range (SMR), the smallest distance between sensor face and measuring object

Installation Conditions

The relative size of the measuring object to the sensor has effects on the linearity deviation for eddy current sensors. Ideally, the measuring object size is at least 4 times the sensor diameter.

MICRO-EPSILON MESSTECHNIK GmbH & Co. KG
 Königbacher Straße 15
 94496 Ortenburg / Germany
 Tel. +49 (0) 8542 / 168-0 / Fax +49 (0)8542 / 168-90
 e-mail info@micro-epsilon.de
 www.micro-epsilon.com

X9771328.01-A021125HDR

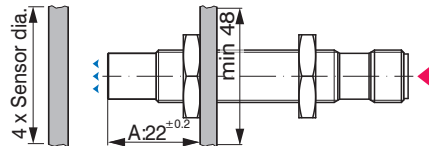

Fig. 4 Assembly, dimensions in mm (not to scale)

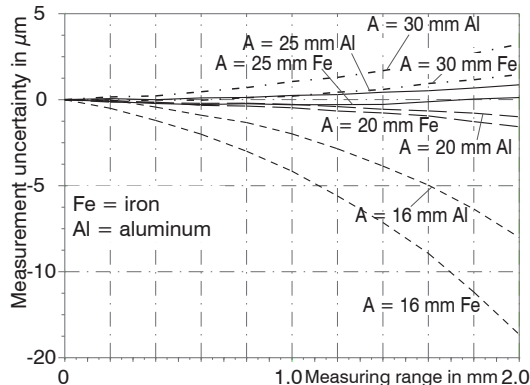

Fig. 5 Measurement uncertainty depending on distance A and target material

Liability for Material Defects

All components of the device have been checked and tested for functionality at the factory. However, if defects occur despite our careful quality control, MICRO-EPSILON or your dealer must be notified immediately.

The liability for material defects is 12 months from delivery.

Within this period, defective parts, except for wearing parts, will be repaired or replaced free of charge, if the device is returned to MICRO-EPSILON with shipping costs prepaid. Any damage that is caused by improper handling, the use of force or by repairs or modifications by third parties is not covered by the liability for material defects. Repairs are carried out exclusively by MICRO-EPSILON.

Further claims can not be made. Claims arising from the purchase contract remain unaffected. In particular, MICRO-EPSILON shall not be liable for any consequential, special, indirect or incidental damage. In the interest of further development, MICRO-EPSILON reserves the right to make design changes without notification.

For translations into other languages, the German version shall prevail.

Decommissioning, Disposal

➡ Remove the power supply and output cable on the sensor.

Incorrect disposal may cause harm to the environment. Dispose of the device, its components and accessories, as well as the packaging materials in compliance with the applicable country-specific waste treatment and disposal regulations of the region of use.



Assembly Instructions
eddyNCDT 3001
 DT3001-U2

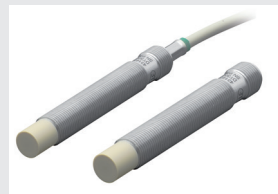

Safety

System operation assumes knowledge of the assembly instructions. The following symbols are used in these assembly instructions:



Indicates a hazardous situation which, if not avoided, may result in minor or moderate injury.



Indicates a situation that may result in property damage if not avoided.



Indicates a user action.



Indicates a tip for users.

Warnings



Connect the power supply and the display/output device according to the safety regulations for electrical equipment.

- > Risk of injury by electric shock
- > Damage to or destruction of the sensor



The supply voltage must not exceed the specified limits.

- > Damage to or destruction of the sensor
- Avoid shocks and impacts to the sensor.
- > Damage to or destruction of the sensor
- Protect the cable against damage.
- > Failure of the measuring device

Intended Use

The eddyNCDT 3001 is designed for use in industrial areas. It is used for displacement, distance, thickness and movement measurement and for position measuring of parts or machine components.

The system must only be operated within the limits specified in the technical data. The system must be used in such a way that no persons are endangered or machines and other material goods are damaged in the event of malfunction or total failure of the system. Take additional precautions for safety and damage prevention in case of safety-related applications.

Technical Data

Model DT3001-	U2A/M-SA
Measuring range	2 mm
Start of measuring range (SMR)	0.4 mm
Output	0.5 ... 9.5 V
Power supply	12 ... 32 V
Protection class	IP 67 (connected)
Operating temperature	0 ... +70 °C (32 ... +158 °F)
Storage temperature	-20 ... +80 °C (-4 ... +176 °F)
Humidity	5 - 95 % (non-condensing)

Pin Assignment

DT3001-SA		PCx/5
Pin	Description	Color
1	+ 24 V supply	brown
2	Displacement signal	white
3	GND	blue
4	Assigned internally	black
5	Assigned internally	gray

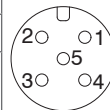

Fig. 1 Male connector side

Installation and Assembly

No sharp or heavy objects should be allowed to affect the cable sheath or the sensor cable, the supply cable and the output cable.

- Check all plug-in connections for firm seating before starting operation.

Construction: The front part of the sensor with encapsulated coil consists of electrically non-conducting materials.

- In the radial direction metal parts in the vicinity may behave similar to the measuring object, rendering the measurement result inaccurate. Please note this by selection of material for sensor mounting and their setup.

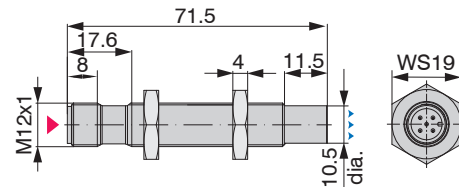

Fig. 2 DT3001-SA, dimensions in mm (not to scale)

▲▲▲ Measuring direction

▲ Male connector side

Measuring Range and Output Characteristics

For each sensor a minimum distance to the measurement object must be maintained. This avoids a measurement uncertainty due to the sensor pressing on the target and mechanical damage to the sensor/target.

Measuring Range and Output Characteristics

For each sensor a minimum distance to the measurement object must be maintained. This avoids a measurement uncertainty due to the sensor pressing on the measurement object and mechanical damage to the sensor/measurement object.

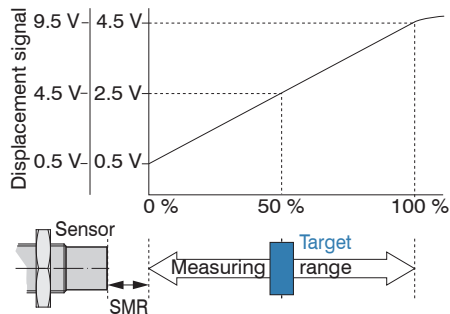

Fig. 4 Start of measuring range (SMR), the smallest distance between sensor face and measuring object

MICRO-EPSILON MESSTECHNIK GmbH & Co. KG
Königbacher Straße 15
94496 Ortenburg / Germany
Tel. +49 8542 / 168-0 / Fax +49 8542 / 168-90
e-mail info@micro-epsilon.de
www.micro-epsilon.com

Installation Conditions

The relative size of the measuring object to the sensor has effects on the linearity deviation for eddy current sensors. Ideally, the measuring object size is at least 4 times the sensor diameter.

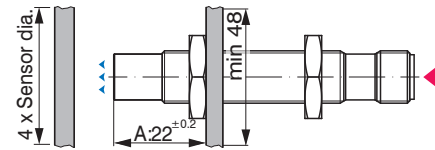

Fig. 5 Assembly, dimensions in mm (not to scale)

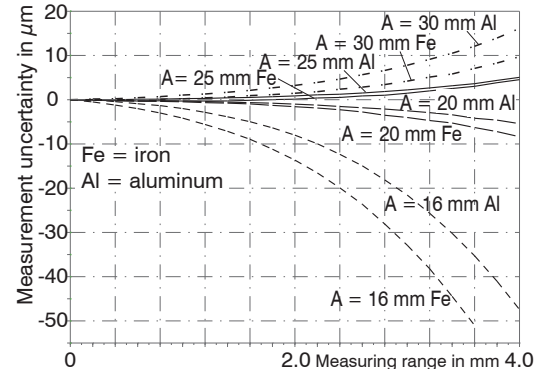

Fig. 6 Measurement uncertainty on distance A and target material

X9771328-A031125HDR

Liability for Material Defects

All components of the device have been checked and tested for functionality at the factory. However, if defects occur despite our careful quality control, MICRO-EPSILON or your dealer must be notified immediately.

The liability for material defects is 12 months from delivery.

Within this period, defective parts, except for wearing parts, will be repaired or replaced free of charge, if the device is returned to MICRO-EPSILON with shipping costs prepaid. Any damage that is caused by improper handling, the use of force or by repairs or modifications by third parties is not covered by the liability for material defects. Repairs are carried out exclusively by MICRO-EPSILON.

Further claims can not be made. Claims arising from the purchase contract remain unaffected. In particular, MICRO-EPSILON shall not be liable for any consequential, special, indirect or incidental damage. In the interest of further development, MICRO-EPSILON reserves the right to make design changes without notification.

For translations into other languages, the German version shall prevail.

Decommissioning, Disposal

➔ Remove the power supply and output cable on the sensor.

Incorrect disposal may cause harm to the environment. Dispose of the device, its components and accessories, as well as the packaging materials in compliance with the applicable country-specific waste treatment and disposal regulations of the region of use.



Assembly Instructions
eddyNCDT 3001
DT3001-U4

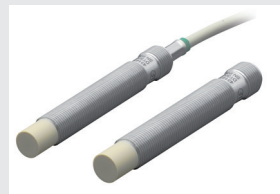

Safety

System operation assumes knowledge of the assembly instructions. The following symbols are used in these assembly instructions:



Indicates a hazardous situation which, if not avoided, may result in minor or moderate injuries.

NOTICE

Indicates a situation that may result in property damage if not avoided.



Indicates a user action.



Indicates a tip for users.

Warnings



Connect the power supply, the display/output device in accordance with the safety regulations for electrical equipment.

- > Risk of injury by electric shock
- > Damage to or destruction of the sensor

NOTICE

The supply voltage must not exceed the specified limits.

- > Damage to or destruction of the sensor
- Avoid shocks and impacts to the sensor.
- > Damage to or destruction of the sensor
- Protect the cable against damage.
- > Failure of the measuring device

Intended Use

The eddyNCDT 3001 is designed for use in industrial areas. It is used for displacement, distance, thickness and movement measurement and for position measuring of parts or machine components.

The system must only be operated within the limits specified in the technical data. The system must be used in such a way that no persons are endangered or machines and other material goods are damaged in the event of malfunction or total failure of the system. Take additional precautions for safety and damage prevention in case of safety-related applications.

Technical Data

Model DT3001-	U4A/M-SA	U4A/M-Cx
Measuring range	4 mm	
Start of measuring range (SMR)	0.4 mm	
Output	0.5 ... 9.5 V	0.5 ... 4.5 V
Power supply	12 ... 32 V	
Protection class	IP 67 (connected)	IP 67
Operating temperature	0 ... +70 °C (32 ... +158 °F)	
Storage temperature	-20 ... +80 °C (-4 ... +176 °F)	
Humidity	5 - 95 % (non-condensing)	

Pin Assignment

DT3001-SA		PCx/5	DT3001-Cx	
Pin	Description	Color	Color	Description
1	+ 24 V supply	brown	Brown	+ 24 V supply
2	Displacement signal	white	Green	Displacement signal
3	GND	blue	White	GND
4	Assigned internally	black	Yellow	Assigned internally
5		gray	Gray	

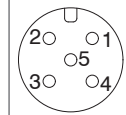
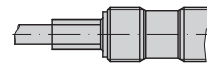

Fig. 1 Male connector side



Installation and Assembly

No sharp or heavy objects should be allowed to affect the cable sheath or the sensor cable, the supply cable and the output cable.



Check all plug-in connections for firm seating before starting operation.

Construction: The front part of the sensor with encapsulated coil consists of electrically non-conducting materials.

i

In the radial direction metal parts in the vicinity may behave similar to the measuring object, rendering the measurement result inaccurate. Please note this by selection of material for sensor mounting and their setup.

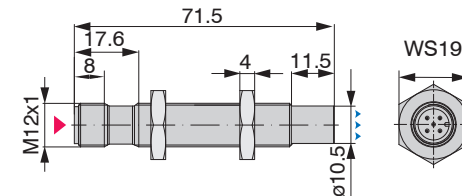

Fig. 2 DT3001-SA, dimensions in mm (not to scale)

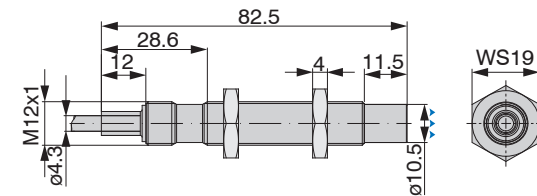

Fig. 3 DT3001-Cx, dimensions in mm (not to scale)

▲▲▲ Measuring direction

▲ Male connector side

Liability for Material Defects

All components of the device have been checked and tested for functionality

at the factory. However, if defects occur despite our careful quality control, MICRO-EPSILON or your dealer must be notified immediately.

The liability for material defects is 12 months from delivery.

Within this period, defective parts, except for wearing parts, will be repaired or replaced free of charge, if the device is returned to MICRO-EPSILON with shipping costs prepaid. Any damage that is caused by improper handling, the use of force or by repairs or modifications by third parties is not covered by the liability for material defects. Repairs are carried out exclusively by MICRO-EPSILON.

Further claims can not be made. Claims arising from the purchase contract remain unaffected. In particular, MICRO-EPSILON shall not be liable for any consequential, special, indirect or incidental damage. In the interest of further development, MICRO-EPSILON reserves the right to make design changes without notification.

For translations into other languages, the German version shall prevail.

Measuring Range and Output Characteristics

For each sensor a minimum distance to the measurement object must be maintained. This avoids a measurement uncertainty due to the sensor pressing on the measurement object and mechanical damage to the sensor/measurement object.

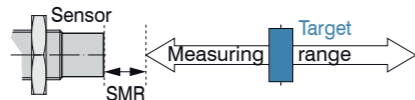
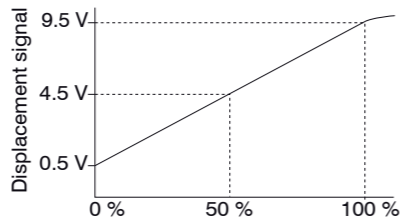

Fig. 3 Start of measuring range (SMR), the smallest distance between sensor face and measuring object

Installation Conditions

The relative size of the measuring object to the sensor has effects on the linearity deviation for eddy current sensors. Ideally, the measuring object size is at least 4 times the sensor diameter.

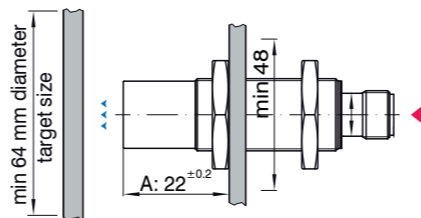

Fig. 4 Assembly, dimensions in mm (not to scale)

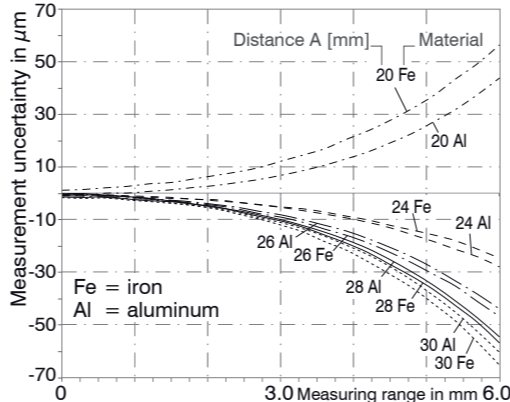

Fig. 5 Measurement uncertainty depending on distance A and target material, DT3001-U6

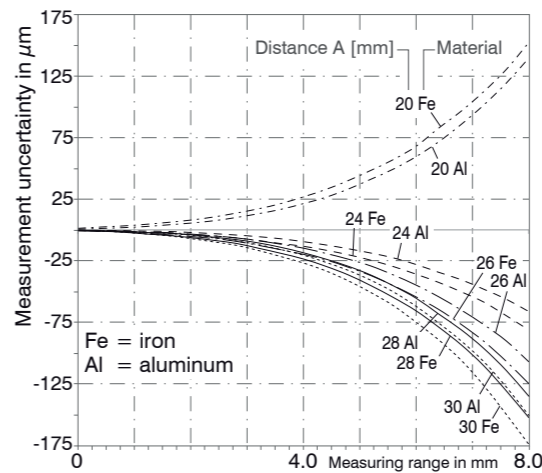

Fig. 6 Measurement uncertainty depending on distance A and target material, DT3001-U8

MICRO-EPSILON MESSTECHNIK GmbH & Co. KG
Königbacher Straße 15
94496 Ortenburg / Germany
Tel. +49 (0) 8542 / 168-0 / Fax +49 (0)8542 / 168-90
e-mail info@micro-epsilon.de
www.micro-epsilon.com

X9771328.02-A011048HDR



Assembly Instructions
eddyNCDT 3001
DT3001-U6
DT3001-U8



Safety

System operation assumes knowledge of the assembly instructions. The following symbols are used in these assembly instructions:



Indicates a hazardous situation which, if not avoided, may result in minor or moderate injuries.

NOTICE

Indicates a situation that may result in property damage if not avoided.



Indicates a user action.



Indicates a tip for users.

Warnings



Connect the power supply, the display/output device in accordance with the safety regulations for electrical equipment.

- > Risk of injury by electric shock
- > Damage to or destruction of the sensor

NOTICE

The supply voltage must not exceed the specified limits.

- > Damage to or destruction of the sensor
- Avoid shocks and impacts to the sensor.
- > Damage to or destruction of the sensor
- Protect the cable against damage.
- > Failure of the measuring device

Proper Use

The eddyNCDT 3001 is designed for use in industrial areas. It is used for displacement, distance, thickness and movement measurement and for position measuring of parts or machine components.

The system must be used in such a way that no persons are endangered or machines and other material goods are damaged in the event of malfunction or total failure of the system. Take additional precautions for safety and damage prevention in case of safety-related applications.

Technical Data

Model	DT3001-	U6-A-SA	U6-M-SA	U8-A-SA	U8-M-SA
Measuring range		6 mm		8 mm	
Start of measuring range		0.6 mm		0.8 mm	
Target material		Aluminum	Steel	Aluminum	Steel
Output	analog digital	0.5 ... 9.5 V RS485 (ME bus protocol)			
Power supply		12 ... 32 V DC			
Connection type		5-pole, M12 connector			
Protection class		IP 67 (connected)			
Operating temperature		-20 ... +70 °C (-4 ... +158 °F)			
Temperature compensation		0 ... +70 °C (+32 ... +158 °F)			
Storage temperature		-20 ... +80 °C (-4 ... +176 °F)			
Humidity		5 - 95 % (non-condensing)			

Installation and Assembly

No sharp or heavy objects should be allowed to affect the cable sheath or the sensor cable, the supply cable and the output cable.



Check all plug-in connections for firm seating before starting operation.

Construction: The front part of the sensor with encapsulated coil consists of electrically non-conducting materials.



In the radial direction metal parts in the vicinity may behave similar to the measuring object, rendering the measurement result inaccurate. Please note this by selection of material for sensor mounting and their setup.

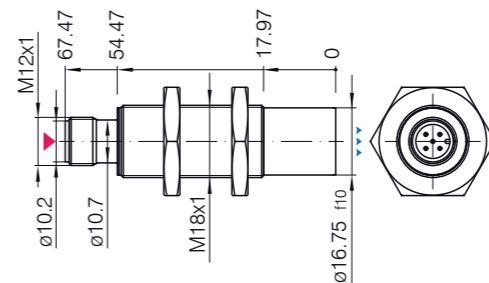

Fig. 1 DT3001-SA, dimensions in mm (not to scale)



Measuring direction



Connector side

Pin Assignment

DT3001-SA		PCx/5 cable
Pin	Description	Color
1	+ 24 V DC supply	brown
2	Analog out	white
3	Ground	blue
4	RS485 (A+)	black
5	RS485 (B-)	gray

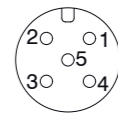

Fig. 2 Male connector sensor side