



Quick Manual

eddyNCDT 3060/3061

eddyNCDT 3070/3071

MICRO-EPSILON
MESSTECHNIK
GmbH & Co. KG
Koenigbacher Str. 15

94496 Ortenburg / Germany

Tel. +49 (0) 8542 / 168-0
Fax +49 (0) 8542 / 168-90
e-mail info@micro-epsilon.com
www.micro-epsilon.com

General

Symbols used

The following symbols are used in this document:



Indicates a hazardous situation which, if not avoided, may result in minor or moderate injury.



Indicates a situation that may result in property damage if not avoided.



Indicates a user action.



Indicates a tip for users.

Measure

Indicates hardware or a software button/menu.



Sensor measurement direction

Warnings



Connect the power supply and the display/output device according to the safety regulations for electrical equipment.

> Risk of injury, damage to or destruction of the sensor and/or the controllers



Avoid shocks and impacts to the sensor and the controller.

> Damage to or destruction of the sensor and/or the controller

The supply voltage must not exceed the specified limits.

> Damage to or destruction of the sensor and/or the controller

Protect the sensor cable against damage.

> Destruction of the sensor, failure of the measurement system.

Intended Use

- The measuring system is designed for use in an industrial environment. It is used for
 - measuring displacement, distance, movement and thickness,
 - measuring the position of parts or machine components.
 - The measuring system must only be operated within the limits specified in the technical data.
- The measuring system must be used in such a way that no persons are endangered or machines and other material goods are damaged in the event of malfunction or total failure of the controller..
- Take additional precautions for safety and damage prevention in case of safety-related applications.

Proper Environment

Temperature range controller	Operation	0 ... +50 °C (+32 ... +122 °F)
	Storage	-10 ... +70 °C (+14 ... +158 °F)
Temperature range sensor, sensor cable	Operation	0 ... +180 °C (+32 ... +356 °F) ¹
		-20 ... +180 °C (-4 ... +356 °F) ²
		-20 ... +200 °C (-4 ... +392 °F) ³
	Storage	0 ... +180 °C (+32 ... +356 °F) ¹
		-50 ... +180 °C (-58 ... +356 °F) ²
		-50 ... +200 °C (-58 ... +392 °F) ³

Protection class IP 67 (plugged)
 Humidity 5 - 95 % (non-condensing)
 Ambient pressure Atmospheric pressure

- 1) Temperature details apply for sensor ES-S04
 2) Temperature details apply for sensor ES-U1
 3) Temperature details apply for standard sensors

Setup, Connection Options

Power supply and signal output are provided via plug connectors on the front of the controller.

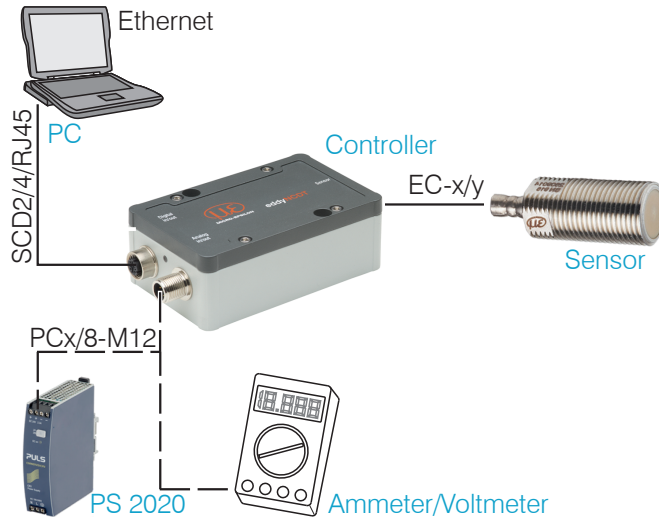

Pin Assignment Supply, Analog Output

PIN	Wire color PCx/8-M12	Signal
2	brown	+24 VDC supply, polarity protection
7	blue	GND supply
1	white	$U_{\text{displacement}}$ (load min. 30 kOhm)
6	pink	GND displacement
8	red	$I_{\text{displacement}}$ (load max. 500 Ohm)
3	green	$U_{\text{temp sensor}}$ / threshold 1
4	yellow	$U_{\text{temp controller}}$ / threshold 2
5	gray	GND temperature, threshold
Shield		

The PCx/8-M12 is a fully assembled power- and output cable; length is 3, 5 or 10 m. The GND analog grounds are connected internally. The outputs are short circuit proof.

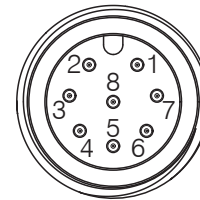

Pin side 8-pin housing plug

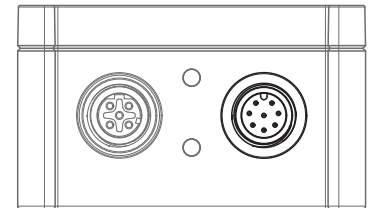

Supply and analog output controller, 8-pin male connector

Measurement Setup, Operating Multiple Sensors

Sensors of the eddyNCDT 306x, 307x series cannot be synchronized. Observe the following installation information regarding the minimum distance between two sensors:

- 3x sensor diameter distance between two unshielded sensors with equal carrier frequency (e. g. low frequency)
- 1.5x sensor diameter distance between two shielded sensors with equal carrier frequency (e. g. low frequency)
- two nearby mounted sensors only as low frequency and high frequency models

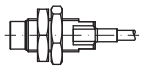
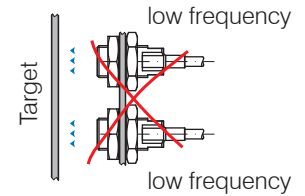
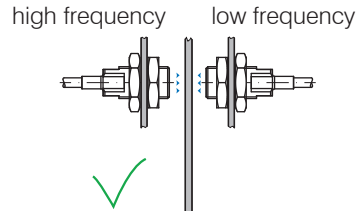
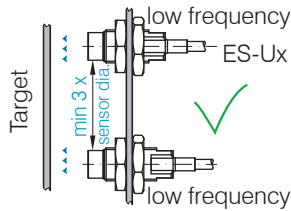
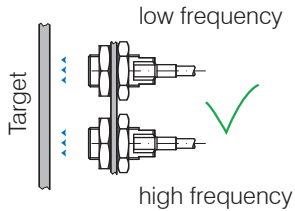

Sensor, ES-Ux

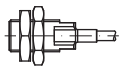

Sensor, ES-Sx

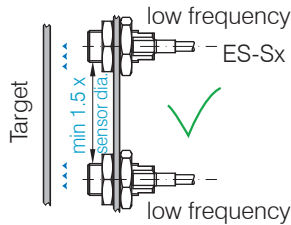

No synchronization required

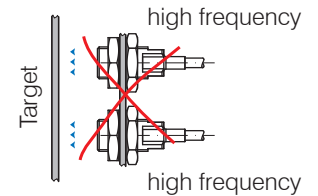
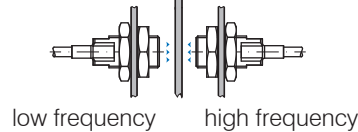

Not possible

LED Controller, LED

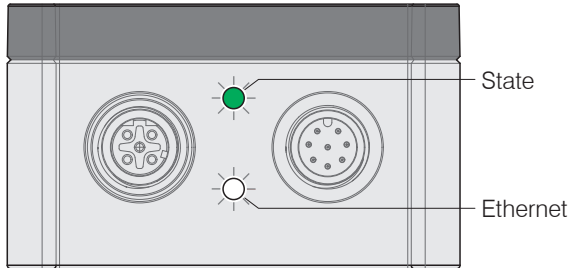

	LED State			
	green	orange	red	off
Controller in operation, measurement runs	●			
Software update	☼			
Sensor or target outside measuring range		☼		
No sensor connected, limit value or warning threshold exceeded, error			●	
No power supply				○

Legend LED



on



flashes



off

Glossary, Analog Output Displacement

- SMR** Start of measuring range. Minimum distance between sensor front and measuring object, sensor specific
- MMR** Mid of measuring range
- EMR** End of measuring range (Start of measuring range + measuring range). Maximum distance between sensor front and measuring object.
- MR** Measuring range

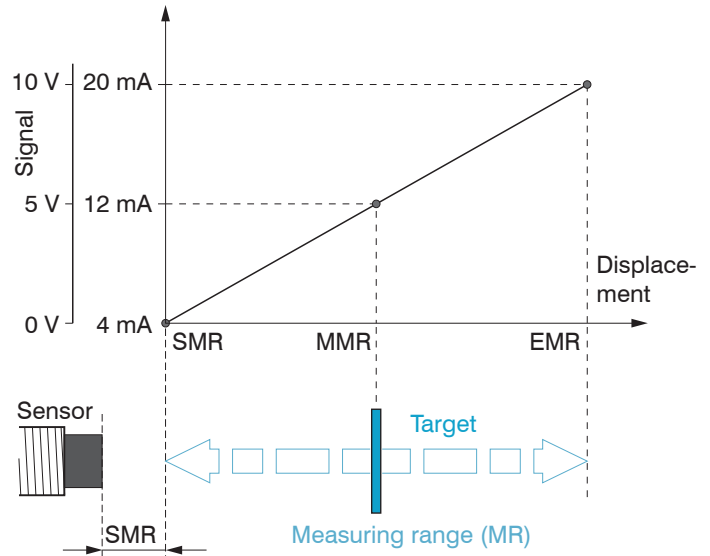

Installation and Assembly

No sharp or heavy objects should be allowed to affect the cable sheath of the sensor cable, the supply cable and the output cable.

i A damaged cable cannot be repaired. Tension on the cable is not permitted!!

Sensor

Unshielded sensors

- Type designation: ES-Ux
- Construction: The sensor cap with encapsulated coil consists of electrically non-conducting materials.

i In the radial direction metal parts in the vicinity may behave similar to the measuring object, rendering the measurement result inaccurate. Please note this by selection of material for sensor mounting and their setup.



Shielded sensors

- Type designation: ES-Sx
- Construction: The sensor enclosed up to its front face with a steel housing with a mounting thread. With it the sensor is shielded from interference through radially near located metal parts.



Start of Measuring Range

For each sensor a minimum distance to the measuring object must be maintained. This avoids a measurement uncertainty due to the sensor pressing on the measuring object and mechanical damage to the sensor/target.

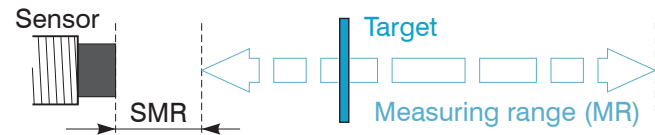

Start of measuring range (SMR), the minimum distance between sensor face and target

Eddy current displacement sensors can be affected in their measurement properties by a metallic holder. Depending on the sensor type, the following sensor mounting should be preferred:

- unshielded sensors: Standard mounting
- shielded sensors: Flush mounting

Standard Mounting

The sensors protrude beyond the metal holder. The installation scenario depicted is used for factory calibration of the sensors at Micro-Epsilon.

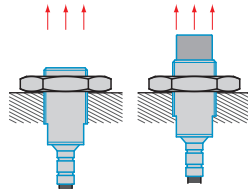

The technical sensor data correspond to standard installation conditions. If you want to achieve the values indicated in the data sheet, we recommend to install the sensor in the same way as it was during calibration.

Sensors with a thread

- ▶ Insert the sensor through the hole in the sensor holder.
- ▶ Screw the sensor tight.
- ▶ Turn the mounting nuts from the delivery on both sides on the thread protruding from the holder.
- ▶ Tighten the mounting nuts carefully to avoid damage, particularly to smaller sensors.

• Prefer the standard mounting of the sensor, because the optimum measurement results can be achieved with this method!

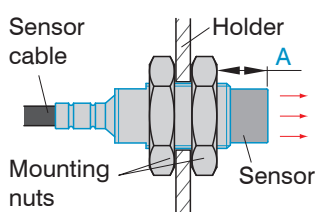

Unshielded sensor with thread in standard mounting

Sensor	ES-U1	ES-U3
Dimension A	8 mm	10 mm

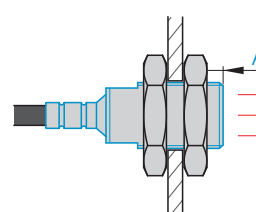

Shielded sensor with thread in standard mounting

Sensor	ES-S2	ES-S4	ES-S04
Dimension A	4 mm	4 mm	2.4 ±0.2 mm

• During calibration maintain the same relative position of the sensor to the holder as for the measurement!

Flush Mounting

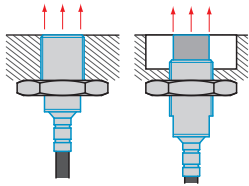

Flush mounting does not correspond to factory calibration. Micro-Epsilon recommends to carry out at least a 3-point field linearization.

i Linearize the measuring system, if possible, when it is exactly arranged (in the same way as it will be arranged later during the measurement process).

Sensors with a thread

- ▶ Mount shielded or unshielded sensors flush in a sensor holder of insulating material (plastic, ceramic, et cetera).
- ▶ Mount the shielded sensors flush in a metal sensor holder.
- ▶ Mount the unshielded sensors flush in a metal sensor holder. Make sure that a recess of a size three times the sensor diameter is used.
- ▶ In all mounting cases screw the sensor into the threaded hole and lock it with the mounting nut.
- ▶ Tighten carefully to avoid damage, particularly to smaller sensors.

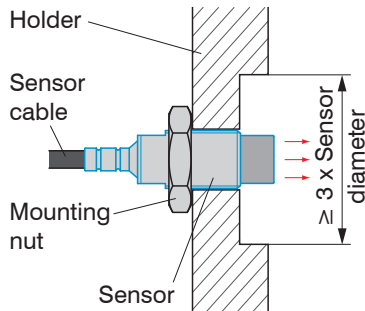

Flush mounting of an unshielded sensor in a metal holder

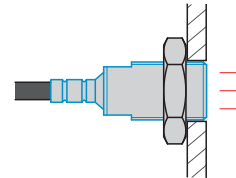

Flush mounting of a shielded sensor in a metal holder.

Target Size

The relative size of the target object compared with the sensor affects the linearity and slope deviation for eddy current sensors.

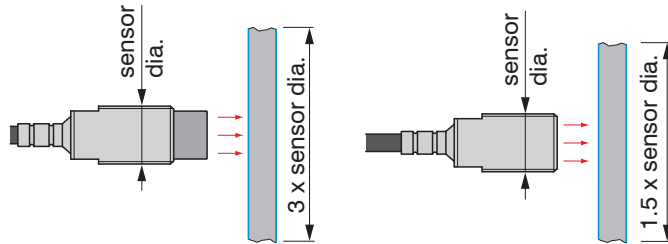

Minimum target size for unshielded sensors

Minimum target size for shielded sensors

If the required object minimum size cannot be complied with, the following aspects must be taken into account for a sufficiently high linearity:

- The size of the target must not change.
- The target must not be moved laterally to the sensor face.

A successful calibration is a prerequisite to minimize linearity errors.

In order to achieve an optimal result, Micro-Epsilon recommends a linearity calibration on the corresponding measuring object. A change of the measuring object size has significant effects on the quality of the measurement results.

Sensor Cable

- ▶ Do not kink the cable - the minimum bending radius is 20 mm (static) or 40 mm (moved).
- ▶ Route the sensor cables in such a way that no sharp-edged or heavy objects can affect the cable sheath.
- ▶ Connect the sensor cable to the controller.

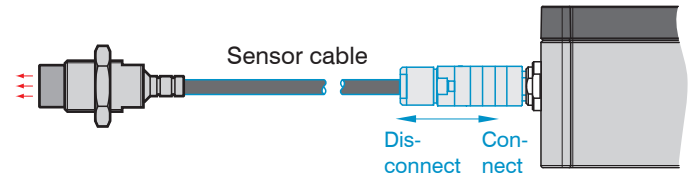

To release the plug-in connection, hold the plug-in connector on the grooved grips (outer sleeves) and pull apart in a straight line.

- Pulling on the cable and the clamping nut locks the connector and does not release the connection. Avoid excessive pulling of the cables
- ▶ Check the plugged connections for firm seating.

Controller

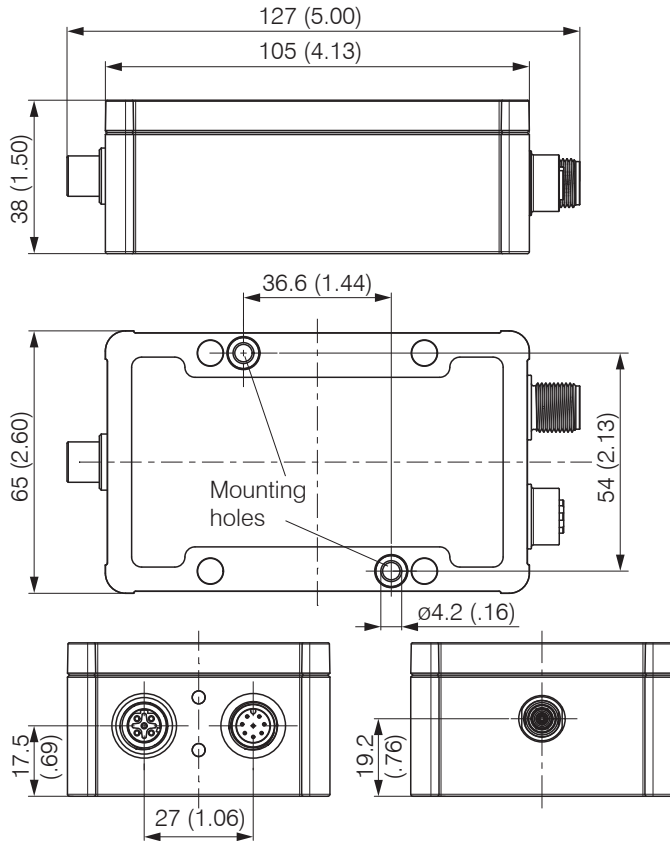

Dimensional drawing controller

Operation Using Ethernet

The controller generates dynamic web pages, that contain the current settings of the controller and the peripherals. The operation is only possible as long as there is an Ethernet connection to the controller.

Requirements



You need a web browser that supports HTML5 (e. g. Firefox \geq 3.5 or Internet Explorer \geq 10) on a PC with a network connection.

Use a LAN cable with M12 screw connection and RJ-45 connector, e.g. as SCD2/4/RJ45 cable available as optional accessory.

The controller is factory-set to direct connection with a static IP address to facilitate initial operation of the control.

If your browser is set to access the Internet via a proxy server, please add the controller IP address to the IP addresses in the browser settings, which are not to be routed over the proxy server. The MAC address of the measuring device is given on the controller rating plate.

“Javascript” and “CSS” must be enabled in the browser so that measurement results can be displayed graphically.

Direct connection to PC		Network
PC with static IP	PC with DHCP	Controller with dynamic IP, PC with DHCP
<p>➡ Connect the controller to a PC via a direct Ethernet connection (LAN).</p>		<p>➡ Connect the controller to a switch.</p>
<p>➡ Start the SensorFinder.exe program.</p> <p>➡ Click the button . Select the designated controller from the list. In order to change the address settings, click the button Change IP... .</p> <ul style="list-style-type: none"> • Address type: static IP-Address • IP address: 169.254.168.150¹ • Subnet mask: 255.255.0.0 <p>➡ Click the button Apply, to transmit the changes to the controller.</p> <p>➡ Click the button Open Web-Page to connect the controller with your default browser.</p> <p>1) Requires that the LAN connection on the PC uses, for example, the following IP address: 169.254.168.1.</p>	<p>Wait until Windows has established a network connection (connection with limited connectivity).</p> <p>➡ Start the SensorFinder.exe program.</p> <p>➡ Click the button . Select the designated controller from the list.</p> <p>➡ Click the button Open WebPage to connect the controller with your default browser.</p>	<p>➡ Enter the controller in the DHCP / register the controller in your IT department.</p> <p>The controller gets assigned an IP address from your DHCP server. You can check this IP address with the SensorFinder.exe program.</p> <p>➡ Start the SensorFinder.exe program.</p> <p>➡ Click the button . Select the designated controller from the list.</p> <p>➡ Click the button Open WebPage to connect the controller with your default browser.</p> <p>Alternatively: If DHCP is used and the DHCP server is linked to the DNS server, access to the controller via a host name of the structure „DT3060_<serial number>“ is possible.</p> <p>➡ Start a web browser on your PC. Type „DT3060_<serial number>“the address bar of your web browser.</p>
<p>Interactive websites for programming the controller and peripherals now appear in the web browser.</p>		

Access via Web Interface

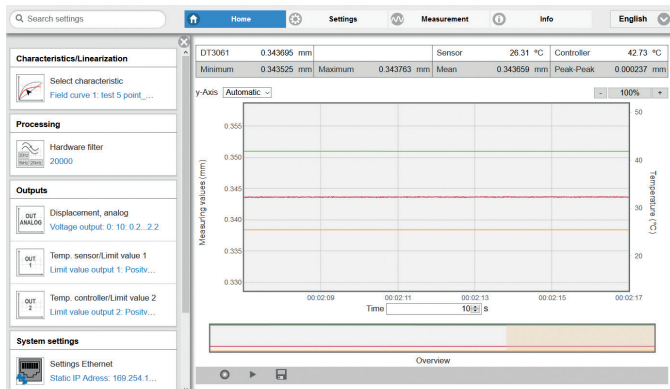

Interactive website after selection of the web interface

Additional help functions (e.g. Settings) are available in the top navigation bar. All settings on the web page are implemented in the controller immediately.

Parallel operation with web browser and Telnet commands is possible; the last setting applies.

The appearance of the web pages can change depending on the functions and the peripherals. Each page contains parameter descriptions and thus tips for configuring the controller.

Operating Menu, Setting Controller Parameters

You can program eddyNCDT 306x, 307x using two different methods simultaneously:

- using the web browser via the sensor web interface
- using the ASCII command set and the terminal program via Ethernet (Telnet).

Login, Change of the User Level

➤ Menu Settings > System settings.

Assigning passwords and the User level prevent unauthorized changes to controller settings.

In delivery state, no password is deposited in the controller. After the controller has been configured, you should enable password protection.

i A firmware update will not change a custom password.

The following functions are accessible for the user:

	User	Professional
Password required	no	yes
View settings	yes	yes
Change settings, linearization, analog output, password	no	yes
Start measuring	yes	yes
Scaling diagrams	yes	yes

Permissions within the user hierarchy

🔑 **Switch user**

Logged in as

User

Password

Login

Change in the professional user level

Enter the password into the `Password` field, and confirm with `Login` in order to switch to the Expert user level.

Change to the User level by clicking the `Logout` button.

In `Professional` mode, you can use the system settings to assign a user-defined password.

Password	Value	All passwords are case-sensitive. Letters and numbers are allowed, but special characters are not permitted. A password consists of max. 16 characters

When a password is assigned for the first time, the field `Old password` remains empty.

Scaling Measuring Range

➤ Menu Settings > Characteristics/Linearization > Scale measuring range.

There are two ways to scale the measuring range of the eddyNCDT 306x, 307x:

- by using the mouse function directly in the graphic
- using the fields `Current measuring range begin` and `Current measuring range end`.

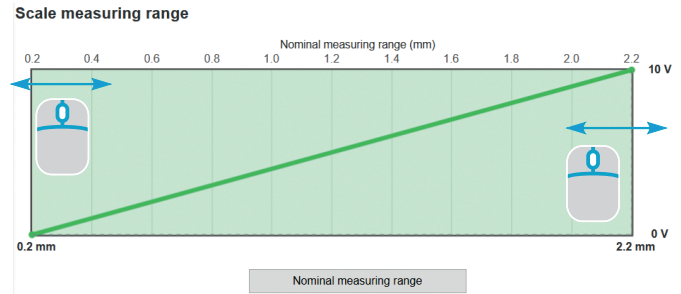

Scaling the measuring range using the pointer

Scaling of the measuring range has an effect on the analog and digital outputs without increasing the resolution. The reference to the scaling of the analog output remains, i.e. the selected start of measuring range corresponds to 0 V on the voltage output.

With the `Nominal measuring range` button, you can reset a manual scaling.

3-Point Linearization

➡ Menu Settings > Characteristics/Linearization > Carry out field linearization.

If the sensor or the measurement object is changed by the user, a calibration must be carried out before the measurement. Here, use the following if possible:

- the original sensor mounting,
- the original measurement object.

i Before a calibration is performed, the measuring device should warm up for about 30 minutes.

➡ Choose 3-point for linearization and the desired unit.

Exemplary linearization using an ES-U3 sensor

Sensor balancing occurs via three distance points which are specified by a comparison standard. You can freely choose the linearization points within the sensor measuring range.

➡ Place the measurement object to the sensor in point 1.



➡ Enter the measurement value (1).

➡ Confirm point 1 with Submit.

➡ Repeat this procedure for the linearization points 2 and 3.

➡ Click on the button Linearize. The system executes the linearization.

You can permanently store the linearization result.

➡ Select a memory location with Select Field characteristic.

➡ Enter a description for the linearization in the field Set name.

➡ Click on the button Save & activate.

Select Characteristic

➔ Menu Settings > Characteristics/Linearization > Current Characteristic.

The DT3060, DT3070 can save one field characteristic curve. The DT3061, DT3071 can save up to four different field characteristic curves, which are based on one a factory calibration respectively.

Current characteristic

Select characteristic

Field curve 2: F14 1.3441 ▼

Name

F14 1.3441

Type

3-Point

Reference factory curve

WK_0002982070_0000_000099

Therefore, you can e.g. store different target or installation scenarios as individual characteristic curve and load them into the controller for the desired application. The **Type** field informs you about the underlying linearization type.

➔ Via the menu Select characteristic, choose the desired characteristic curve or linearization for your measurement.

Import, Export

Manage settings

Export settings

Export

Import settings

Durchsuchen... Keine Dat...sgewählt

Choose settings

Controller settings

Ethernet settings

Import

➔ Menu Settings > System settings > Manage settings.

Here you can export all controller settings in a file or reimport them from a file.

Controller settings Hardware filter, limit value outputs

Ethernet settings IP address, subnet mask

Scaling Temperature Analog Output

This function is possible with the DT3061 and DT3071 controller.

➔ Menu Settings > Outputs > Temperature.

The temperature output enables to output the controller or sensor temperature.

➔ Choose the types **Temperature sensor** or **Temperature controller**.

Max. output range: 0 V ... 5 V

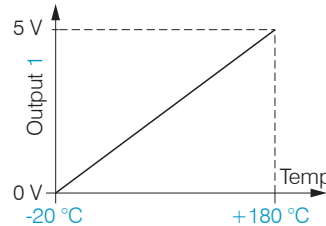

Sensor temperature

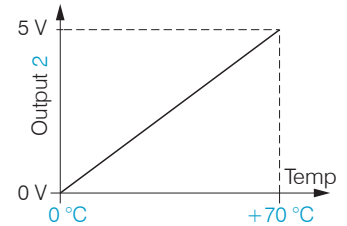

Controller temperature

The accuracy of the temperature measurement depends on the installation scenario. Reproducibility is high.

Scaling Displacement Analog Output

➤ Menu Settings > Outputs > Displacement analog.

Max. output range: 4 mA ... 20 mA or 0 V ... 10 V

Output amplification ΔI_{OUT} : 16 mA or ΔU_{OUT} : 10 V; corresponds to 100 % MR

In every case, 2 points are used which characterize the start and the end of the analog output.

Displacement, analog

Type of analog output

Voltage output ▼

Start of range (V)

4

End of range (V)

6

Measuring range scaling from...to (mm)

0.2...2.2

Together with the Change scaling measuring range function, you can adapt the analog output to your individual requirements.

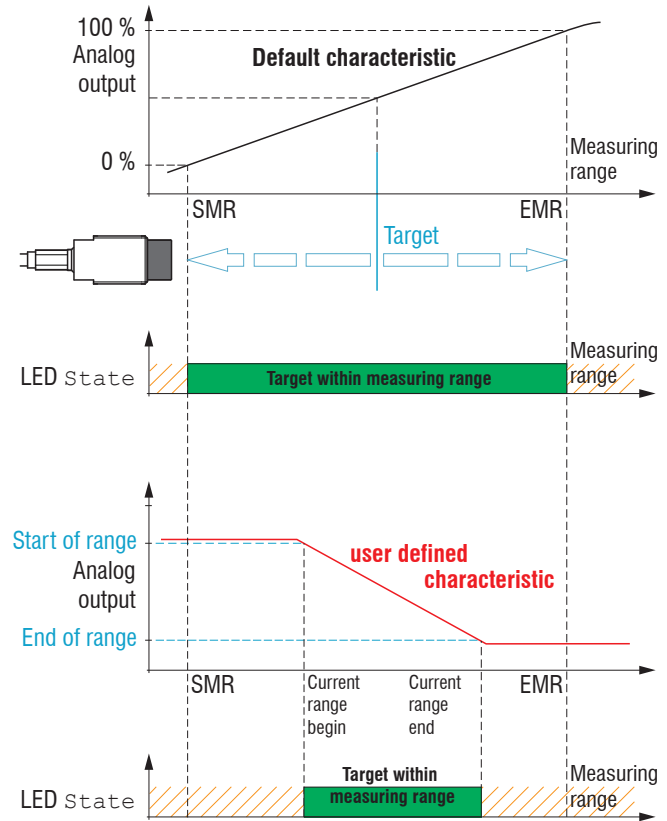

Default characteristic (black), reverse user defined characteristic (red)

Limit Output

This function is available with controller DT3061, DT3071.

▶ Menu Settings > Outputs > Limit value 1/2.

The eddyNCDT 3061, 3071 can check the measurement result to adjustable limits. This means that threshold values can be monitored, impermissible tolerances detected and sorting criteria realized.

The reference for the limit monitoring is selectable and applies to the current characteristic.

Type: Relative | Peak-To-Peak | Dynamic.

Relative	The threshold values A/B refer to the set Reference value
Peak-To-Peak	The threshold values A/B refer to the peak-to-peak value calculated in blocks (Peak-to-Peak Δt parameter).
Dynamic	The threshold values A/B refer to a continuously calculated, moving average (Average Δt).

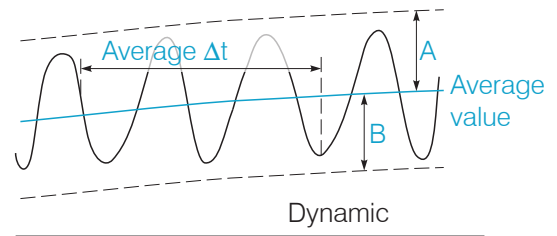
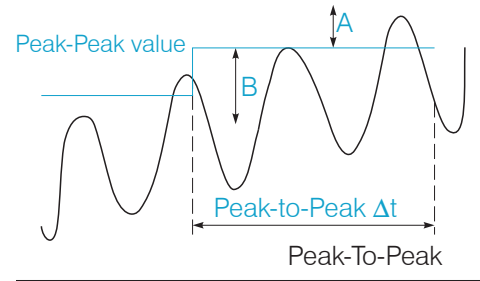
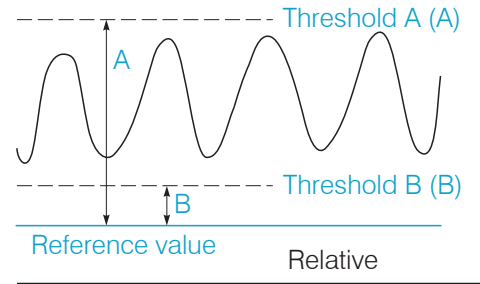

References for limit monitoring

Temp. controller/Limit value 2

Type of output

Logic

Type limit value output

(V: Measuring value)

Threshold A (mm)

Threshold B (mm)

Reference value (mm)

Hysteresis H (mm)

Delay time t1 (ms)

Hold time t2 (ms)

Parameters for limit monitoring

eddyNCDT 306x / 307x

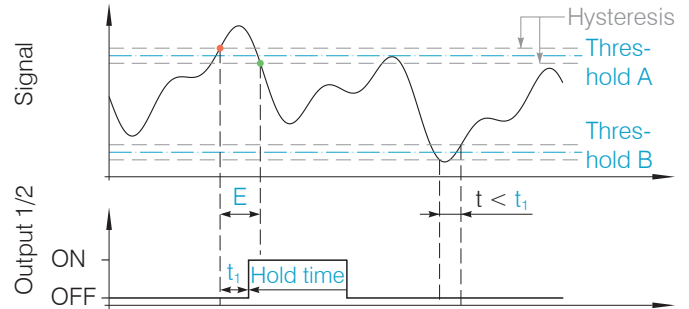

Timing limit monitoring, event (E) < hold time, logic: positive

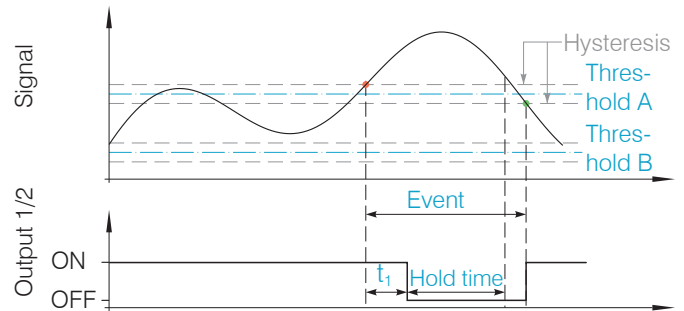

Timing limit monitoring, event (E) > hold time, logic: negative

- t Duration of limit infringement
- t_1 Delay time
- $t < t_1$ Limit output passive
- $t \geq t_1$ Limit output active

Positioning the Target

► Position the target within the sensor measuring range.

The value for the start of the measuring range (SMR) depends on the sensor. This value can be found in the technical data of the sensor.

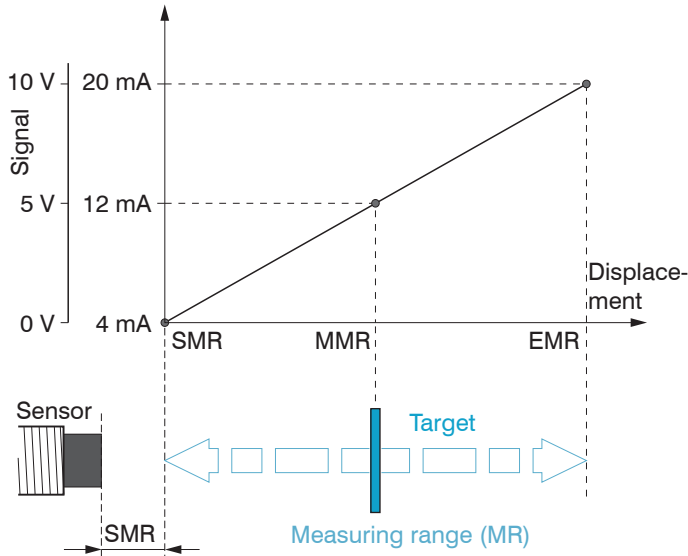

SMR Start of measuring range
MMR Midrange
EMR End of measuring range

Distance Measurements

► Switch to the Measurement menu.

► Click the Start measuring button.

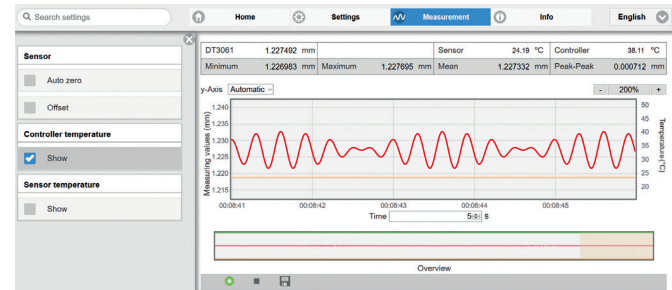

Statistic values are calculated in the web interface. Clicking onto the start/stop measuring button starts/stops the calculation. At the beginning of a measurement, the statistic values are reset. During a measurement, the statistic values are updated with each new data package received by the controller.

Service, Repair

In the event of a defect on the controller, sensor or sensor cable, the parts concerned must be sent back for repair or replacement. In the case of faults the cause of which is not clearly identifiable, the whole measuring system must be sent back to

MICRO-EPSILON MESSTECHNIK
GmbH & Co. KG
Koenigbacher Str. 15
94496 Ortenburg / Germany
Tel. +49 (0) 8542 / 168-0
Fax +49 (0) 8542 / 168-90
info@micro-epsilon.com
www.micro-epsilon.com

Liability for Material Defects

All components of the device have been checked and tested for functionality at the factory. However, if defects occur despite our careful quality control, MICRO-EPSILON or your dealer must be notified immediately.

The liability for material defects is 12 months from delivery. Within this period, defective parts, except for wearing parts, will be repaired or replaced free of charge, if the device is returned to MICRO-EPSILON with shipping costs prepaid. Any damage that is caused by improper handling, the use of force or by repairs or modifications by third parties is not covered by the liability for material defects. Repairs are carried out exclusively by MICRO-EPSILON.

Further claims can not be made. Claims arising from the purchase contract remain unaffected. In particular, MICRO-EPSILON shall not be liable for any consequential, special, indirect or incidental damage. In the interest of further development, MICRO-EPSILON reserves the right to make design changes without notification.

For translations into other languages, the German version shall prevail.



MICRO-EPSILON MESSTECHNIK GmbH & Co. KG
Koenigbacher Str. 15 · 94496 Ortenburg / Germany
Tel. +49 (0) 8542 / 168-0 · Fax +49 (0) 8542 / 168-90
info@micro-epsilon.com · www.micro-epsilon.com

X9691385-A032040SWE

© MICRO-EPSILON MESSTECHNIK

